

Installation Instructions Sheer Visions Decomatic Headrail

Mounting Hardware

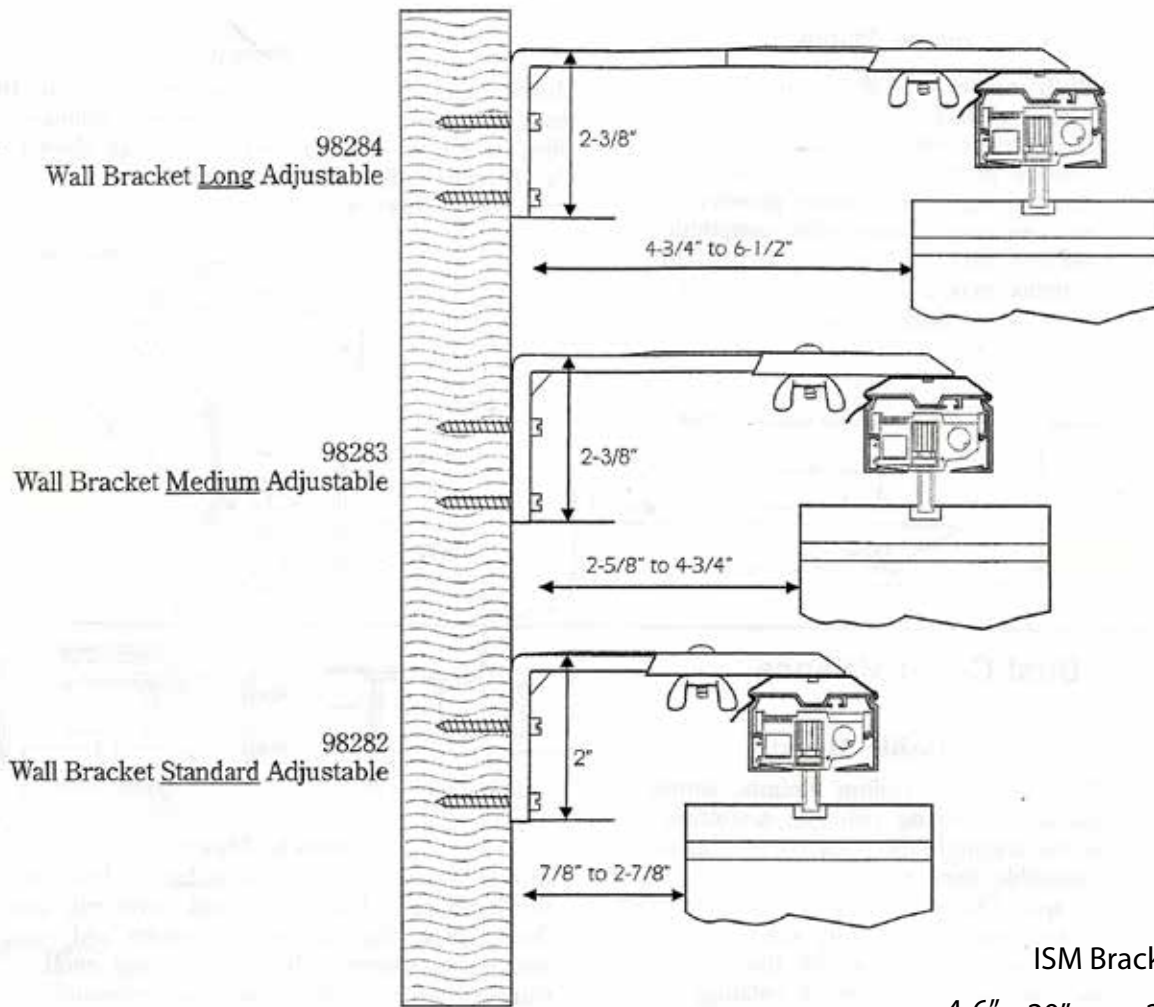

ISM Bracket Spacing

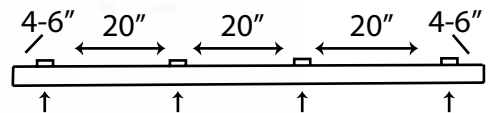

Bracket should be spaced $4\text{-}6"$ from each end.
Remaining brackets should be evenly spaced $20"$ apart.

OSM Bracket Spacing

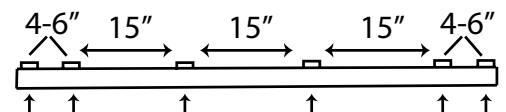

Brackets should be spaced $4\text{-}6"$ at each end.
Remaining brackets should be evenly spaced $15"$ apart.

Dust Cover Valance

Inside Mount

With inside or ceiling mount, simply install the ceiling clip and mounting screw through the valance as shown. Assemble corners and returns as shown. The returns may need trimmed to size with heavy duty scissors. Make sure the vane doesn't hit the inside face of the valance when rotating.

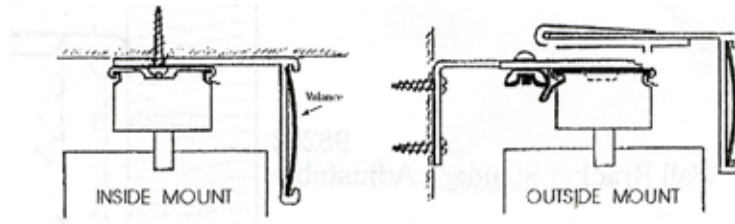

Outside Mount

Mount head rail and snap the valance clips onto the head rail. Insert the dust cover top into the valance clips, assemble corners and returns as shown. The returns may need trimmed to size with heavy duty scissors.

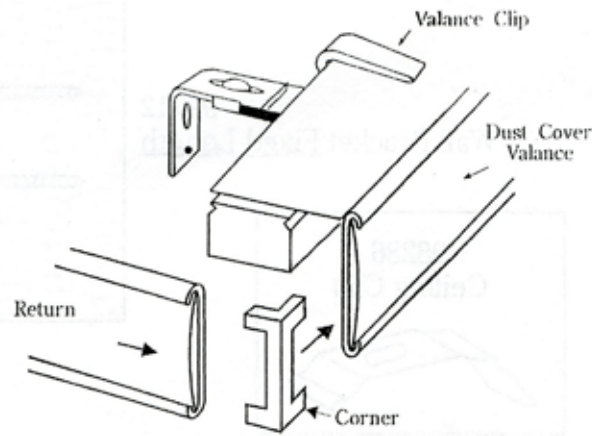

ONE-WAY DRAW UNITS - CORDING DIRECTIONS

Heat two ends together and fasten to lead carrier.

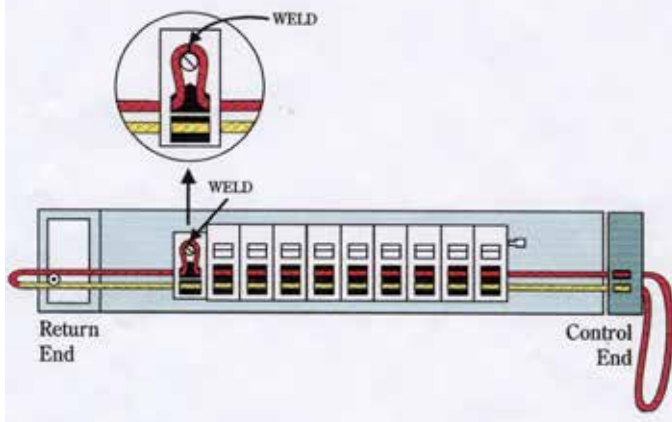

SPLIT DRAW TRACK - CORDING DIRECTIONS

Heat two ends together and fasten to lead carrier.

Loop upper cord around screw, adjust and tighten.

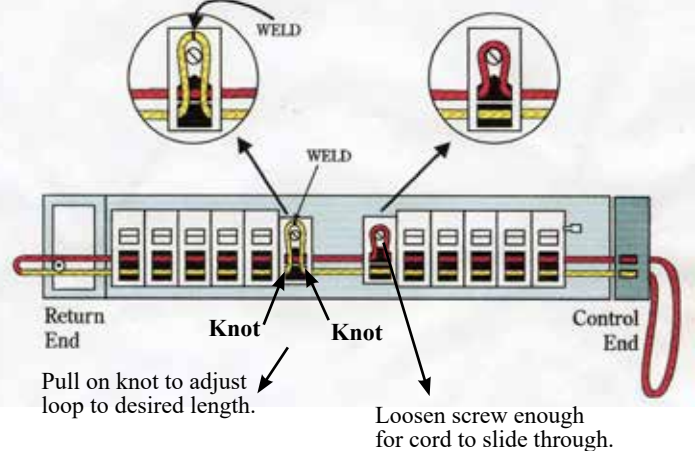

Control Chain:

- One full cycle of the control chain (13-1/2") will self align the vanes and stoms if out of sync.



Sheer Visions One-Way or Split Draw Vertical Blinds

Thank you for choosing Sheer Visions Vertical Blinds. With proper installation and care, your new blinds will provide many years of beauty and performance.

Tools Needed

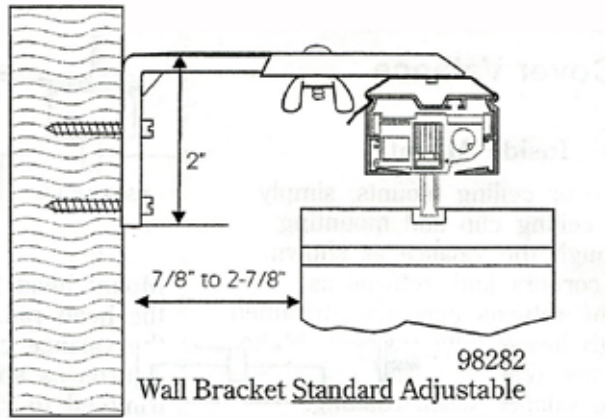
Power Drill, 1/4" Driver and drill bits
Tape Measure
Flat blade Screwdriver
Phillips Screwdriver
Pencil
Level

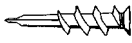

Mounting Surface	Fastener
Wood	#6 Hex Head Provided 
Drywall, Plaster	Wall Anchors Not Provided 
Metal	Sheet Metal Not Provided 

- Begin by installing vertical headrail and louvers
- Open louvers and traverse blind across opening. (See Fig. 1)

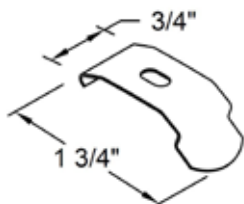

Mounting Clip

Fig. 1

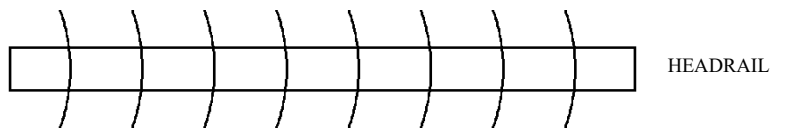

- Face finished hem of *Sheer Visions* toward room.
- Drape the fabric over your shoulder to free your hands. This supports the fabric and reduces the likelihood of the snaps coming undone. Begin at the top with the left louver. (See Fig. 2)

- Slide the pocket formed by the pre-snapped tab over the front edge of the first louver.

- Reach behind the headrail, fold the tab (male snap) over the rear half of the louver and snap it to its female counterpart. The louver pin should be between the two tabs.

- Pull the other side of the pocket over Louver 1 and tuck the fabric around.

- Use Vel-Coins to secure fabric to the louver. Instructions for Vel-Coins are on page 2. The fabric will have to be tucked around the last louver also.

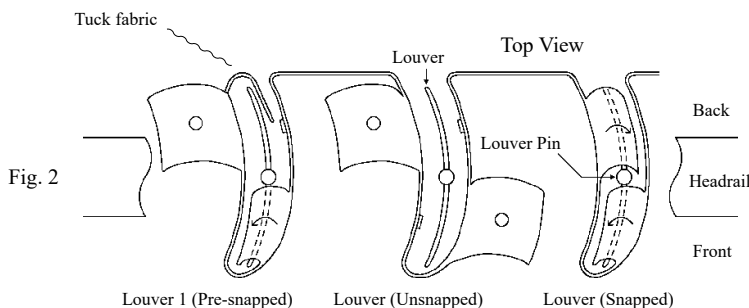

- Move to the 2nd louver, join snaps 2 and 3 (see Fig. 3) to form the front tab. Slide the tab over the front of the louver.
- Next, join snaps 1 and 4 behind the louver pin to form the rear tab. Repeat this procedure for the remaining louvers.

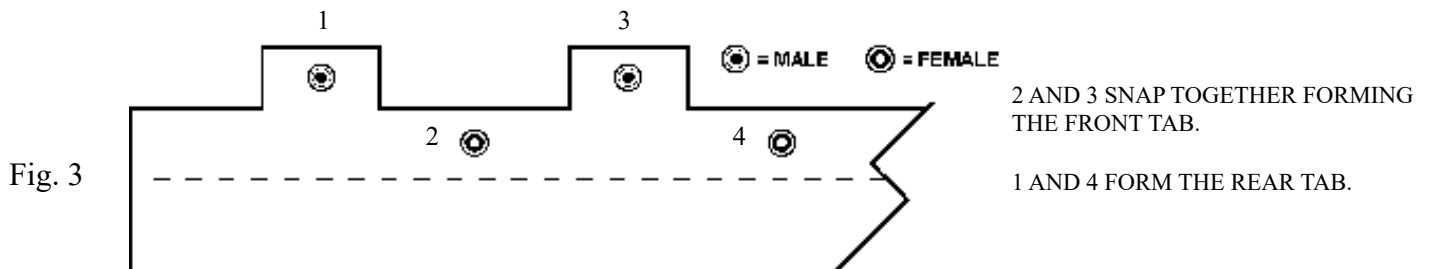

- Continue across the top of the window before addressing the bottom of the product. Once the top is completed, move back to the bottom of the first louver.
- Insert each louver into the pocket created by the cotton or Dennison Tack.
- Gently bow the louver to fit into the pocket at the bottom of the sheer, being careful not to snag the fabric.
- Continue to work across the window placing the remaining louvers into their pleats.

SPLIT DRAW NOTE: Before rotating the louvers to the closed position, traverse the louvers open approximately 1" to 2". This will allow the lead louvers to overlap properly.

Vel-Coin Installation

In some Sheer Visions shadings, on certain fabrics, you may experience slight billowing of fabric. This occurs on the two outside louvers on a one-way draw (see Figure 1). If the condition exists on a split draw shading, it will be on the two outside louvers as well as the two inside louvers (see Figure 2).

Vel-Coins are included that can be adhered to the louver and then in the corresponding location on the fabric (see Figure 3).

- The hook Vel-Coin is attached to the outside edge of the louver.
- The loop Vel-Coin should be inset 1/2" on the fabric wrap. This will ensure vertical alignment of the louver and the wrap.

The number of Vel-Coins shipped with your order is dependent on the Sheer Visions length ordered and whether the shading is split draw or one-way draw. Vel-Coins are also included with your Sheer Visions shading in the event that you experience the billowing of fabric on your shading.

