

Lafayette Interior Fashions

Contract Department

www.lafvb.com/lifcontract

765-464-2500 ♦ quotes@lafvb.com

Faux Wood Blinds

wonderwood®



316 White Rock - 2", 2 1/2"



570 Chalk - 2"

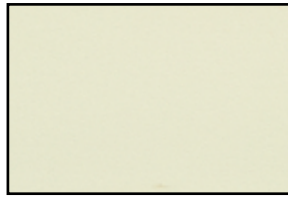

315 Pumice - 2"



471 Adobe - 2", 2 1/2"

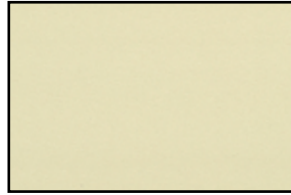

887 Sandstone - 2"

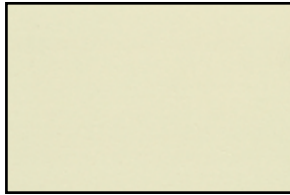

466 Stucco - 2", 2 1/2"

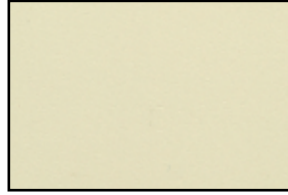

312 Earth - 2"

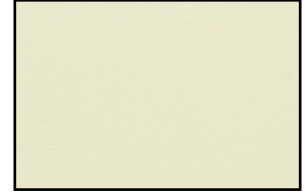

313 Flagstone - 2"

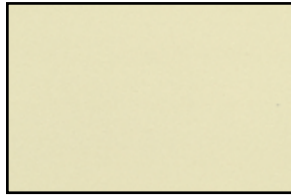

478 Stone - 2", 2 1/2"

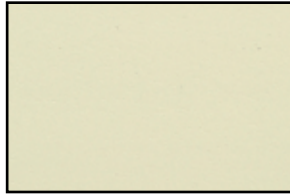

314 Gravel - 2"

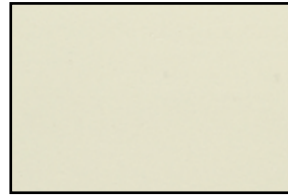

462 Gypsum - 2", 2 1/2"



574 Limestone - 2"



485 Putty - 2"



252 Cobblestone - 2", 2 1/2"



254 River Rock - 2", 2 1/2"



251 Sand - 2"



253 Granite - 2", 2 1/2"



488 Clay - 2"



250 Straw - 2"



256 Brownstone - 2", 2 1/2"



257 Brick - 2"

Find NFPA 701 FR test results
in the Materials Library at www.lafvb.com
Select Product Type: Blinds
Select Product Name: Wonderwood Faux Wood Blinds



Product Features

- Fits rectangular window openings
- NFPA 701 FR Rated
 - Test results are located in the Materials Library at www.lafvb.com
- 2" in 21 colors
- 2 1/2" slat in 9 colors
- Standard Valance
- Signature Tassel and Stop Ball
- Rectangular Bottom Rail
- Cord Tilt
- Lifetime Limited Warranty

Options

- Deluxe Valance
- Multiple Blinds on One Headrail
- Light Ban with EZE Clean
- Wand Tilt
- Stationary Specialty Shapes

Dimensional Guidelines

- Maximum Width: 72"
- Maximum Length: 96"

Standard Rectangular

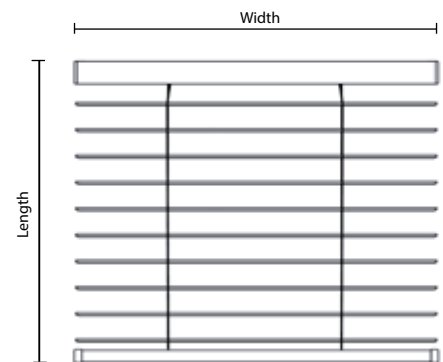
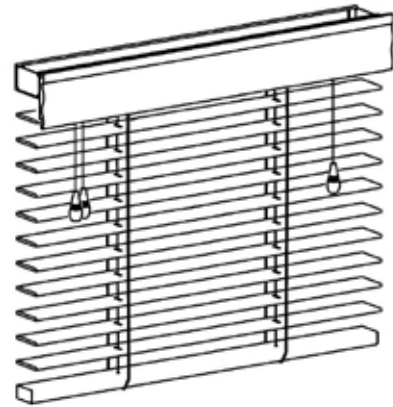

Low Profile Headrail and Bracket

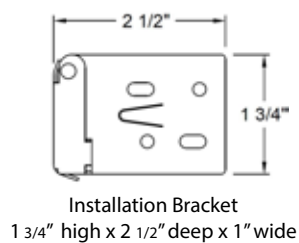
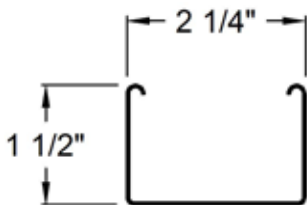

Valances

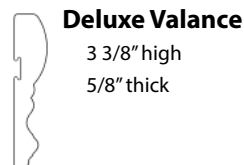

Stationary Specialty

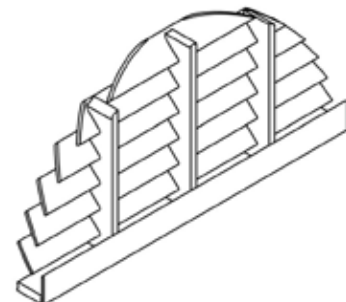

Online template service available for specialty shape templates.

