

Mink MI 1124 – 2122 BV

Mink MI 1124 – 1502 BP



MI 1502 BV

Description

The Busch Mink is a rotary claw-type, positive displacement, dry pump designed for either pressure or vacuum applications. The Mink is available as a single-stage or two-stage vacuum pump.

Vacuum or pressure is produced by two non-contacting rotors in an oil-free pumping chamber. The dry, non-contacting design makes the Mink ideal for pneumatic conveying, printing, soil remediation, and any application

where dust particles may be present. Wearing parts are separated from the pumping chamber which leads to a longer pump life with low maintenance.

Features

- Non-contacting design
- Dry (oil-free) pumping chamber
- Air-cooled
- Low maintenance – no wear in pumping chamber
- Simple, modular construction
- Suitable for variable speed applications
- Discharge silencers on vacuum models; inlet silencers on pressure models
- Frame rails on models MI 1354-1502
- Suitable for dusty environments
- Integral relief valve (where necessary)
- Inlet filters on pressure models

Dry Rotary Claw Pressure or Vacuum Pumps

Operating Principle

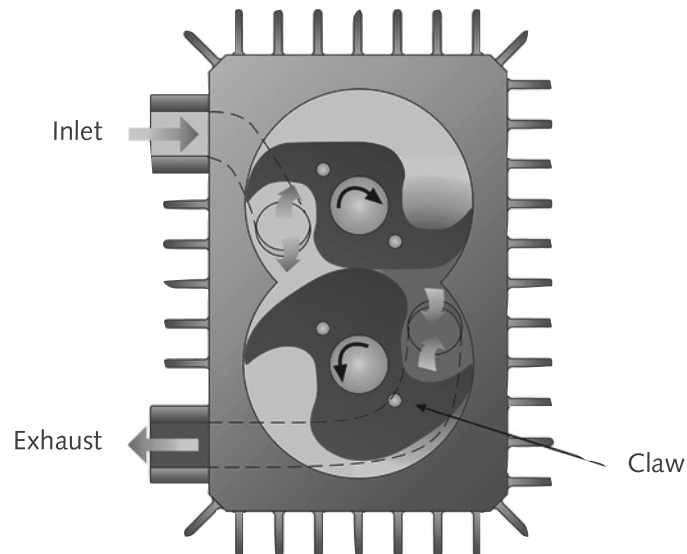

Operating Principle

Inside the pump housing, two claw shaped rotors take in air as they rotate in opposite directions. The air is compressed by the rotors, then discharged through a silencer to atmosphere. The non-return valve incorporated into the inlet flange prevents air from back flowing into the pumping

chamber when the pump is turned off. Mink MI dry rotary claw direct drive pumps are driven by a C-face motor, and the two rotors are synchronized by gears. A wide range of accessories allows optimum adaptation to many applications.

Applications

- Wood Industry
- Pneumatic conveying
- Transport and lifting systems
- Medical technology
- Central vacuum systems
- Packaging industry
- Plastics industry
- Food industry
- Printing industry
- Ceramics and brick industry
- Environmental technology
- Vacuum sewage
- Textile industry
- Paper industry
- Beverage industry

Technical Data

Pumping Speed vs. Inlet Pressure

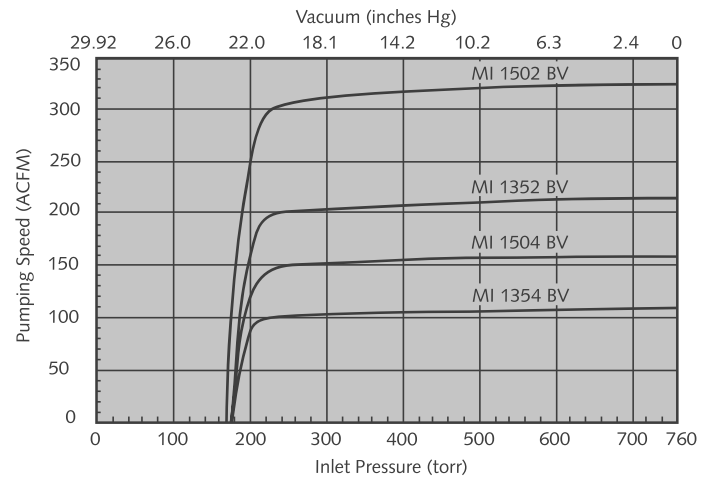
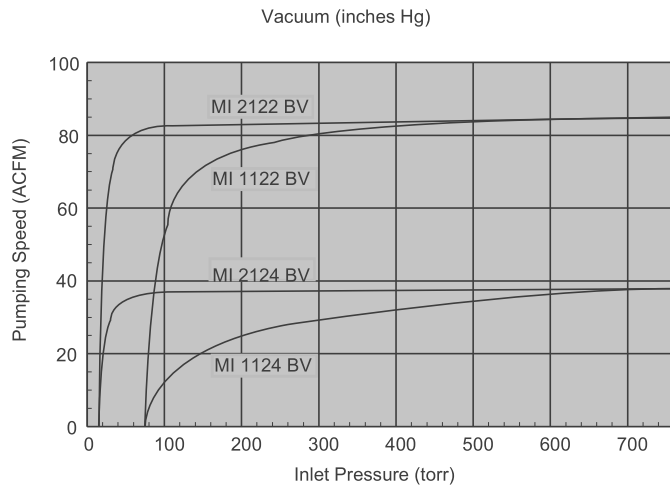

Model MI (Vacuum)		1124 BV	1122 BV	1354 BV	1504 BV	1352 BV	1502 BV	2124 BV*	2122 BV*
Nominal pumping speed	ACFM	38	85	108	160	216	325	38	85
Free air displacement	CFM	50	100	125	188	250	376	50	100
End vacuum	"Hg	26.9	26.9	23.1	23.1	23.1	23.4	29.3	29.3
End vacuum	torr	75	75	173	173	173	165	15	15
Motor rating	HP	3.0	5.0	5.0	7.5	10	15	3	7.5
Motor speed	RPM	1800	3600	1800	1800	3600	3600	1800	3600
Approx. weight	Lbs	231	253	680	760	775	950	325	352
Inlet pipe connection	Inches	1 ¹ / ₄	1 ¹ / ₄	2	2	2	3	1 ¹ / ₄	1 ¹ / ₄
Discharge pipe connection	Inches	1 ¹ / ₂	1 ¹ / ₂	2	2	2	3	1 ¹ / ₂	1 ¹ / ₂
Sound rating	dBA	78	84	81	81	85	85	77	84

*Two stage models



Pumping Speed vs. Discharge Pressure

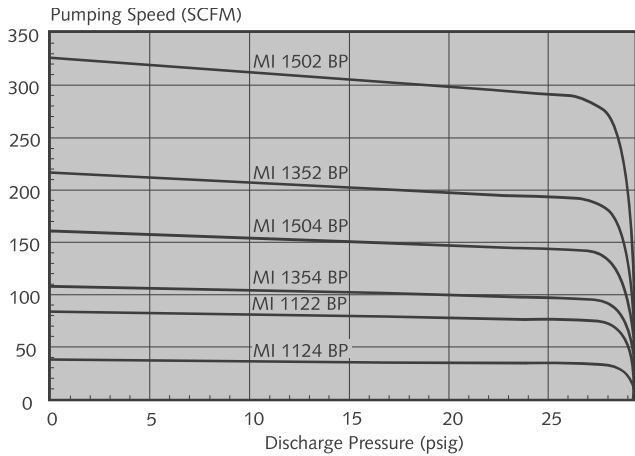

Brake Horsepower vs. Discharge Pressure

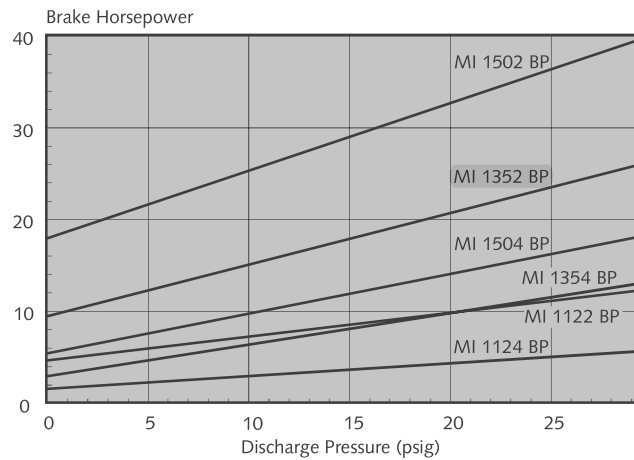

Model MI (Pressure)		1124 BP	1122 BP	1354 BP	1504 BP	1352 BP	1502 BP
Nominal pumping speed	SCFM	38	85	108	160	216	325
Free air displacement	CFM	50	100	125	188	250	376
Maximum pressure	psig	29.4	29.4	29.4	29.4	29.4	29.4
Motor rating	HP	7.5	15	15	20	30	40
Motor speed	RPM	1800	3600	1800	1800	3600	3600
Approx. weight	Lbs	243	297	1025	1075	1195	1350
Discharge pipe connection	Inches	1 ¹ / ₄	1 ¹ / ₄	2	2	2	3
Sound rating	dBA	76	84	85	85	86	87

Dry Rotary Claw Pressure or Vacuum Pumps



Dimensions

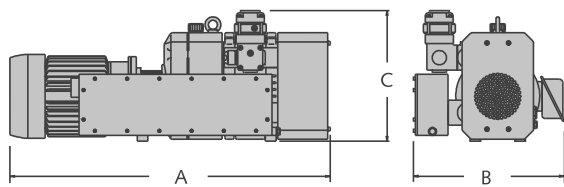

Models 1124 BV, 1122 BV, 2122 BV, 2124 BV

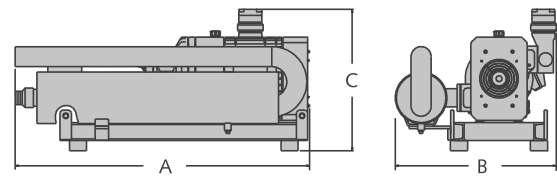

Models 1354 BV, 1504 BV, 1352 BV, 1502 BV

Model MI	1124 BV	1122 BV	1354 BV	1504 BV	1352 BV	1502 BV	2124 BV*	2122 BV*
A length	35 ³ / ₈	35 ³ / ₈	51	52 ¹ / ₈	51	52 ¹ / ₈	39 ¹ / ₄	42 ⁵ / ₁₆
B width	16 ⁵ / ₈	16 ⁵ / ₈	28 ¹ / ₈	29 ¹ / ₄	29 ¹ / ₈	31 ⁵ / ₁₆	17 ¹ / ₄	20 ⁷ / ₈
C height	14 ³ / ₈	14 ³ / ₈	25 ⁷ / ₈	24 ³ / ₄	25 ⁷ / ₈	28 ⁵ / ₈	15 ¹¹ / ₁₆	15 ¹¹ / ₁₆

All dimensions in inches unless otherwise noted. * Two stage models

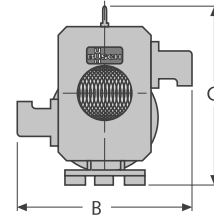
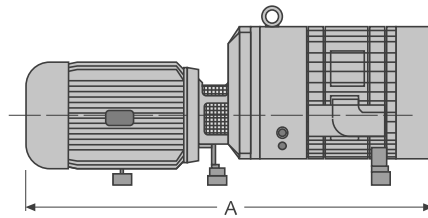

Model MI	1124 BP	1122 BP	1354 BP	1504 BP	1352 BP	1502 BP
A length	39 ¹ / ₈	39 ¹ / ₈	44 ¹¹ / ₁₆	43 ⁵ / ₁₆	48 ⁵ / ₁₆	49 ¹⁵ / ₁₆
B width	22 ¹ / ₂	22 ¹ / ₂	19 ¹ / ₁₆	19 ¹ / ₂	19 ¹ / ₁₆	25 ¹⁵ / ₁₆
C height	16 ³ / ₄	16 ³ / ₄	17 ³ / ₄	16 ³ / ₄	20 ¹⁵ / ₁₆	20 ³ / ₄

All dimensions in inches unless otherwise noted.

Mink Cutaway

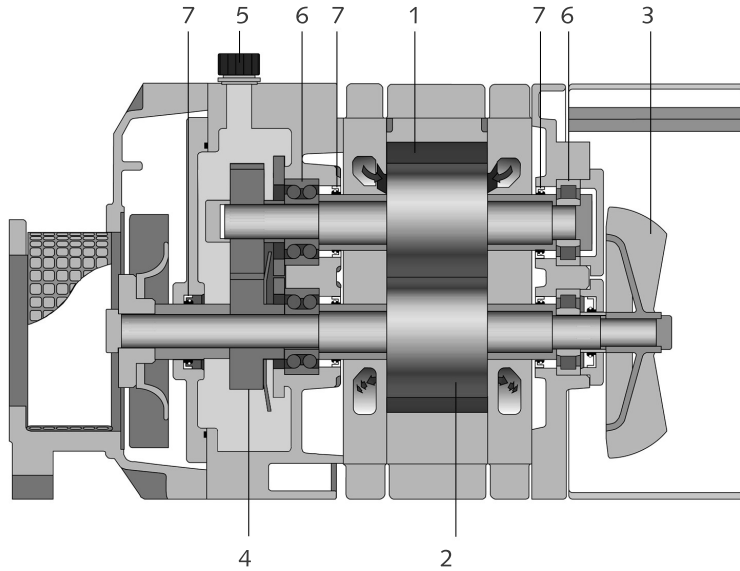

- 1. Pumping chamber
- 2. Rotors
- 3. Cooling fan*
- 4. Timing gears
- 5. Oil fill plug
- 6. Bearings
- 7. Shaft seals

*33 watt, 115 volt, 1 phase, 60 Hz, electric cooling fan on models 1354-1502

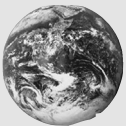

Busch - all over the world in industry

ISO 9001 Registered Company

**Busch, Inc. 516 Viking Drive Virginia Beach, VA 23452
Phone (757) 463-7800 FAX (757) 463-7407**

**www.buschpump.com
1-800-USA-PUMP**