

Applications

- Process Industry
- Power Industry
- Chemical Industry
- Oil and Gas
- Metals and Mining
- Water & Waste Water
- Pulp and Paper

Basket Strainers

Pressures to 3705 PSIG
Temperatures to 800°F

FEATURES

- Fabricated Construction
- Filtration down to 40 microns
- Large strainer baskets
- Both compact and high capacity units are available

MATERIALS OF CONSTRUCTION

- Bronze
- Carbon Steel
- Stainless Steel
- Other materials upon request

END CONNECTIONS

- Flat Faced
- Raised Face
- Buttweld
- Threaded (NPT)
- Socketweld

SIZES

- Fabricated - custom sized to meet requirement

RATINGS

- ASME Class 150
- ASME Class 300
- ASME Class 600
- ASME Class 900
- ASME Class 1500





FB SERIES FABRICATED BASKET STRAINERS

PRESSURES TO 3705 PSIG (255 BARG)
TEMPERATURES TO 800°F (427°C)

Multiple and custom body configurations for tight installation, performance and/or economy

Multi-baskets minimize downtime

Stainless steel perforated baskets are standard

Cover lifting lug standard on sizes 10" and larger

Bottom/blowdown outlet is standard

Drain connection with plug furnished as standard

APPLICATIONS

Water, Oil Systems
Other Liquid Systems
Protection of Pumps, Meters, Valves, etc.

MODELS

FB1 - Standard Body
FB2 - Undersized Body (most economical)
FB3 - Oversized Body (highest OARs)
FB4 - Low Profile Body w/Pleated Bskt
FB5 - Low Profile Body w/Multiple Bskts

APPLICABLE CODES

Designed/Manufactured to meet ASME B31.1,
ASME B31.3 or ASME B31.4 and/or ASME Section VIII, Div. I.
CRN available in all provinces
Welders Certified to ASME Section IX

PRESSURE/TEMPERATURE CHART

ASME B16.34

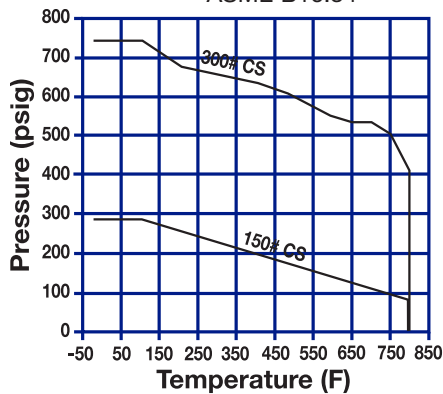

For Quick Opening Covers Ratings, see page 11

For higher pressure classes and other materials, consult factory.

OPTIONS

Other materials, sizes and/or configurations
Quick Opening Covers - See page 11
Other screen, mesh or wedgewire
Vent and/or differential pressure connections
"U" stamped vessels
Steam jacketing
Backflush or backwash
NACE MR010-75 Certification
External/internal coatings
Offset inlet/outlet Nozzles
600# flanges and higher
Pleated Baskets for higher Open Area Ratios
Air Vents
Consult factory for other options

FB Series Ordering Code

Model	Material	Inlet Size	Class	Con- nection	Dash	Cover Type	Perf	Mesh
F B 1 C H 1 R - B 2 3								
1	2	3	4	5	6	7	8	9
10	11							

Model - Position 1 - 3
FB1 - Standard Body
FB2 - Undersized Body
FB3 - Oversized Body
FB4 - Low Profile Body w/Pleated Bskt
FB5 - Low Profile Body w/Multiple Bskts
FBZ - Custom Configuration

Material - Position 4
C - Carbon Steel
L - Low Temp CS
V - 304 SS
T - 316 SS
M - Monel
H - Hastelloy
Z - Other

Inlet Size - Position 5
H - 2
J - 2½
K - 3
M - 4
N - 5
P - 6
Q - 8
R - 10
S - 12
T - 14
U - 16
V - 18
W - 20
X - 22
Y - 24
1 - 28
2 - 30
3 - 36
4 - 40
Z - Other

Class - Position 6
1 - 150
3 - 300
4 - 600
5 - 900
Z - Other

Connection - Position 7
B - Buttweld*
F - Flat Face Flg
N - NPT
J - Ring Joint Flg
R - Raised Face Flg
K - Socketweld
Z - Other

Dash - Position 8

1. For Buttweld connections please specify mating pipe schedule

Cover Type - Position 9
B - Bolted
C - Bolted w/C-Clamp
D - Bolted w/Davit
J - Bolted w/Hinge
H - T - Bolt Hinged
T - Threaded Hinged
Y - Yoke Hinged
Z - Other

For any variations, use the part numbering system above but clearly indicate the additional requirements.

Perf - Position 10
304 SS Material²
A - None
B - 3/64"
1 - 1/32"
2 - 1/16"
3 - 3/32"
4 - 1/8"
5 - 5/32"
6 - 3/16"
7 - 7/32"
8 - 1/4"
9 - 3/8"
Z - Other

2. For other screen material, contact factory.

Mesh² - Position 11
A - None
1 - 10
2 - 20
3 - 30
4 - 40
5 - 50
6 - 60
7 - 80
8 - 100
9 - 120
Z - Other

FB1 SERIES FABRICATED BASKET STRAINERS

SPECIFICATION

Strainer shall be designed and manufactured to meet ASME B31.1, ASME B31.3 or ASME B31.4 and/or ASME Section VIII Div. I. The Strainer body shall be fabricated steel or other specified material and inlet/outlet connections shall be in line. The Strainer shall have a single basket with a slant top. The Strainer shall have a bottom blowdown outlet. The screen shall be size ____ perforated stainless steel. The Strainer shall have an inlet size of ____ and open area ratio of _____. The Basket Strainer shall be SSI FB _____.

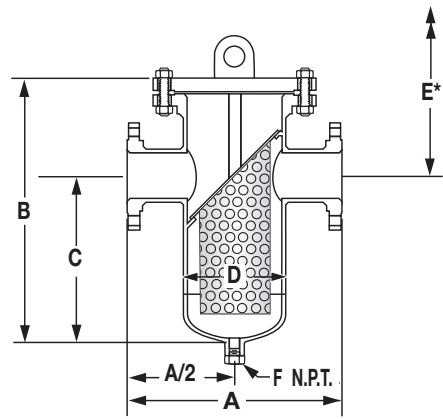

MATERIALS OF CONSTRUCTION (Carbon Steel Shown†)

Body	A53S/B or A106-B
Nozzles	A53S/B or A106-B
Flanges	SA105
Heads	SA234-WPB or SA516-70
Reinforcement Pads ²	SA516-70
Couplings	SA105
Plug	SA105
Basket ¹	304 SS
Gasket ¹	304 SS Spiral Wound
Stud	SA193-B7
Nut	SA194-2H

† Other Materials Available. Consult factory.

1. Recommended Spare Parts.

2. When required.

Material specification will change when NACE MR01-75 is specified.

Standard cover is bolted.

Cover lifting lug standard on 10" sizes and larger.

Class 150# and 300# flanges are standard.

Class 600# and higher available on request.

*Distance required for basket removal.

Connections*: 2" – 24"
RF, FF, RTJ Flanged or Butt weld

*Larger sizes available. Consult Factory.

For Butt weld connection please specify mating pipe schedule.

SCREEN OPENINGS

SIZE	STANDARD SCREEN	MATERIALS
2" – 12"	1/8 Perf.	304 SS
14" – 24"	3/16 Perf.	304 SS

FB1 DIMENSIONS inches (mm) AND WEIGHTS pounds (kg)

150# and 300# Class Flanges shown (For 600#, 900# and 1500# dimensions and weights, contact factory.)

Inlet/ Outlet	Body	A		B		C		D	E		F	Weight			
		Class 150	Class 300	Class 150	Class 300	Class 150	Class 300		Class 150	Class 300		Class 150		Class 300	
												Cover ¹	Unit	Cover ¹	Unit
2 (50)	6 (150)	12 (305)	14 ⁷ / ₈ (378)	18 ⁵ / ₈ (473)	22 (559)	11 ¹ / ₈ (283)	12 (305)	6 ⁵ / ₈ (168)	25 (635)	28 (711)	1/2 (15)	26 (12)	85 (39)	50 (23)	195 (88)
3 (80)	8 (200)	14 (356)	16 ¹ / ₂ (419)	20 ¹ / ₂ (521)	25 (635)	12 ¹ / ₂ (318)	15 ³ / ₄ (400)	8 ⁵ / ₈ (219)	28 ¹ / ₂ (724)	34 ¹ / ₄ (870)	3/4 (20)	45 (20)	140 (64)	81 (37)	250 (113)
4 (100)	8 (200)	16 (406)	18 ⁵ / ₈ (473)	22 ¹ / ₄ (565)	26 (660)	14 (356)	15 ⁷ / ₈ (403)	8 ⁵ / ₈ (219)	30 ¹ / ₂ (775)	36 ¹ / ₈ (918)	1 (25)	45 (20)	145 (66)	81 (37)	300 (136)
5 (125)	10 (250)	18 (457)	20 ¹ / ₄ (514)	24 ¹ / ₄ (616)	28 (711)	17 (432)	17 ¹ / ₈ (435)	10 ³ / ₄ (273)	30 ¹ / ₂ (775)	38 ⁷ / ₈ (988)	1 (25)	70 (32)	160 (73)	125 (57)	400 (181)
6 (150)	10 (250)	20 (508)	24 ¹ / ₂ (622)	27 (686)	30 ³ / ₄ (781)	17 (432)	19 ¹ / ₈ (486)	10 ³ / ₄ (273)	36 (914)	42 ³ / ₈ (1076)	1 (25)	70 (32)	205 (93)	125 (57)	480 (218)
8 (200)	12 (300)	22 (559)	24 ⁷ / ₈ (632)	32 (813)	35 ¹ / ₂ (902)	21 (533)	22 (559)	12 ³ / ₄ (324)	43 (1092)	55 ³ / ₄ (1416)	1 1/2 (40)	110 (50)	420 (191)	185 (84)	681 (309)
10 (250)	16 (400)	32 (813)	35 ³ / ₈ (899)	41 ¹ / ₂ (1054)	42 ¹ / ₂ (1080)	25 (635)	27 ¹ / ₄ (692)	16 (406)	58 (1473)	57 ¹ / ₄ (1454)	1 1/2 (40)	180 (82)	650 (295)	295 (134)	1100 (499)
12 (300)	18 (450)	35 (889)	39 ³ / ₈ (1000)	44 ³ / ₄ (1137)	47 ³ / ₄ (1213)	28 (711)	30 ³ / ₈ (772)	18 (457)	61 ¹ / ₂ (1562)	65 ¹ / ₈ (1654)	1 1/2 (40)	220 (100)	1205 (547)	395 (179)	1650 (748)
14 (350)	20 (500)	37 (940)	41 ¹ / ₂ (1054)	48 ³ / ₄ (1238)	49 ⁵ / ₈ (1260)	33 (838)	33 (838)	20 (508)	64 ¹ / ₂ (1638)	72 (1829)	2 (50)	285 (129)	1600 (726)	505 (229)	2600 (1179)
16 (400)	24 (600)	42 (1067)	47 ¹ / ₂ (1207)	54 ¹ / ₄ (1378)	60 (1524)	36 (914)	38 ⁷ / ₈ (988)	24 (610)	72 ¹ / ₂ (1842)	81 ¹ / ₈ (2061)	2 (50)	430 (195)	1965 (891)	790 (358)	2750 (1247)
18 (450)	24 (600)	46.5 (1181)	*	60 (1524)	*	40 (1016)	*	24 (610)	80 (2032)	*	2 (50)	430 (195)	2200 (998)	*	*
20 (500)	30 (750)	52 (1321)	*	68 (1727)	*	46 (1168)	*	30 (762)	90 (2286)	*	2 (50)	965 (438)	3200 (1452)	*	*
24 (600)	36 (900)	64 (1626)	*	82 ³ / ₄ (2102)	*	55 (1397)	*	36 (914)	110 ¹ / ₂ (2807)	*	2 (50)	1540 (699)	4500 (2041)	*	*

Dimensions shown are for reference only. Consult factory for certified prints when required.

* Consult factory.

1. Weight and dimension with Bolted Cover.

FB2 SERIES FABRICATED BASKET STRAINERS

SPECIFICATION

Strainer shall be designed and manufactured to meet ASME B31.1, ASME B31.3 or ASME B31.4 and/or ASME Section VIII Div. I. The Strainer body shall be fabricated steel or other specified material and inlet/outlet connections shall be in line. The Strainer shall have a single basket with a slant top. The Strainer shall have a bottom blowdown outlet. The screen shall be size ____ perforated stainless steel. The Strainer shall have an inlet size of ____ and open area ratio of _____. The Basket Strainer shall be SSI FB _____.

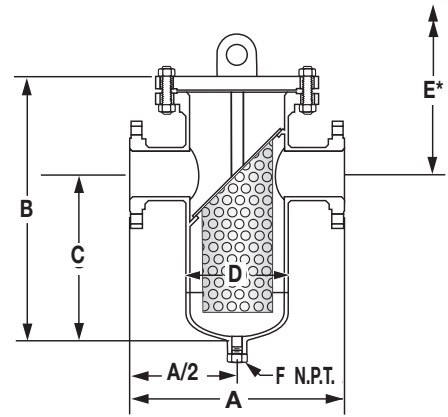

Standard cover is bolted.

Cover lifting lug standard on 10" sizes and larger.

Class 150# and 300# flanges are standard.

Class 600# and higher available on request.

*Distance required for basket removal.

Connections*: 2"– 24"
RF, FF, RTJ Flanged or Buttweld

*Larger sizes available. Consult Factory. For Buttweld connection please specify mating pipe schedule.

MATERIALS OF CONSTRUCTION (Carbon Steel Shown†)

Body	SA53S/B or SA106-B
Nozzles	SA53S/B or SA106-B
Flanges	SA105
Heads	SA234-WPB or SA516-70
Reinforcement Pads ²	SA516-70
Couplings	SA105
Plug	SA105
Basket ¹	304 SS
Gasket ¹	304 SS Spiral Wound
Stud	SA193-B7
Nut	SA194-2H

† Other Materials Available. Consult factory.

1. Recommended Spare Parts.

2. When required.

Material specification will change when NACE MR01-75 is specified.

SCREEN OPENINGS

SIZE	STANDARD SCREEN	MATERIALS
2" – 12"	1/8 Perf.	304 SS
14" – 24"	3/16 Perf.	304 SS

FB2 DIMENSIONS inches (mm) AND WEIGHTS pounds (kg)

150# and 300# Class Flanges shown (For 600#, 900# and 1500# dimensions and weights, contact factory.)

Inlet/Outlet	Body	A		B		C		D	E		F	Weight-150#		Weight-300#	
		150	300	150	300	150	300		150	300		Cover ¹	Unit	Cover ¹	Unit
2 (50)	4 (100)	10 (254)	12¾ (324)	14¾ (378)	20 (508)	8¾ (226)	12 (305)	4½ (114)	22¾ (562)	26 (660)	½ (13)	17 (7.7)	34 (15.4)	28 (12.7)	50 (22.7)
3 (80)	6 (150)	13½ (343)	11½ (292)	19¾ (486)	18¾ (480)	11¾ (295)	9 (229)	6¾ (168)	20¾ (527)	21¾ (552)	½ (13)	26 (11.8)	106 (48.1)	50 (22.7)	160 (72.6)
4 (100)	6 (150)	14 (356)	12¾ (308)	17¾ (454)	20 (508)	10¾ (270)	10⅝ (262)	6¾ (168)	21¾ (536)	21¾ (543)	½ (13)	26 (11.8)	114 (51.7)	50 (22.7)	175 (79.4)
6 (150)	8 (200)	14¾ (378)	15¾ (403)	22¾ (562)	23¾ (607)	12½ (318)	12½ (318)	8¾ (219)	27¾ (692)	29⅝ (754)	¾ (19)	45 (20.4)	140 (63.5)	81 (36.7)	225 (102.0)
8 (200)	10 (250)	18 (457)	24¾ (622)	30⅝ (773)	30¾ (781)	19½ (495)	19¾ (486)	10¾ (273)	36¾ (917)	35¾ (908)	1 (25)	70 (31.7)	350 (158.7)	125 (56.7)	480 (217.7)
10 (250)	12 (300)	20 (508)	25¾ (654)	36¾ (927)	36¾ (937)	21 (533)	21 (533)	12¾ (324)	32¾ (819)	45¾ (1153)	1½ (38)	110 (49.9)	400 (181.4)	185 (83.9)	800 (362.8)
12 (300)	14 (350)	26¾ (667)	27¾ (702)	37¾ (956)	39¾ (1010)	22 (559)	21 (533)	14 (356)	46¾ (1191)	50⅝ (1281)	1½ (38)	139 (63.0)	595 (269.8)	241 (109.3)	930 (421.8)
14 (350)	16 (400)	30 (762)	* *	41¾ (1057)	* *	26 (660)	* *	16 (406)	46¾ (1178)	* *	1½ (38)	180 (81.6)	1208 (547.8)	295 (133.8)	* *
16 (400)	18 (450)	34 (864)	* *	45¾ (1162)	* *	30 (762)	* *	18 (457)	55 (1397)	* *	2 (51)	285 (129.3)	1900 (861.7)	505 (229.0)	* *
18 (450)	20 (500)	38¾ (975)	* *	48.12 (1222)	* *	28 (711)	* *	20 (508)	59¾ (1518)	* *	2 (51)	285 (129.3)	1965 (891.2)	505 (229.0)	* *
20 (500)	24 (600)	40¾ (1035)	* *	55.63 (1413)	* *	32 (813)	* *	24 (610)	66¾ (1689)	* *	2 (51)	430 (195.0)	2600 (1179.1)	790 (358.3)	* *
24 (600)	30 (750)	45¾ (1149)	* *	62.88 (1597)	* *	38 (965)	* *	30 (762)	79 (2007)	* *	2 (51)	965 (437.6)	4000 (1814.1)	* *	* *

Dimensions shown are for reference only. Consult factory for certified prints when required.

* Consult factory.

1. Weight and dimensions with Bolted Cover.

FB3 SERIES FABRICATED BASKET STRAINERS

SPECIFICATION

Strainer shall be designed and manufactured to meet ASME B31.1, ASME B31.3 or ASME B31.4 and/or ASME Section VIII Div. I. The Strainer body shall be fabricated steel or other specified material and inlet/outlet connections shall be in line. The Strainer shall have a single basket with a slant top. The Strainer shall have a bottom blowdown outlet. The screen shall be size ____ perforated stainless steel. The Strainer shall have an inlet size of ____ and open area ratio of _____. The Basket Strainer shall be SSI FB _____.

MATERIALS OF CONSTRUCTION (Carbon Steel Shown†)

BodySA53S/B or SA106-B
 NozzlesSA53S/B or SA106-B
 FlangesSA105
 HeadsSA234-WPB or SA516-70
 Reinforcement Pads².....SA516-70
 CouplingsSA105
 PlugSA105
 Basket¹.....304 SS
 Gasket¹.....304 SS Spiral Wound
 StudSA193-B7
 NutSA194-2H

† Other Materials Available. Consult factory.

1. Recommended Spare Parts.

2. When required.

Material specification will change when NACE MR01-75 is specified.

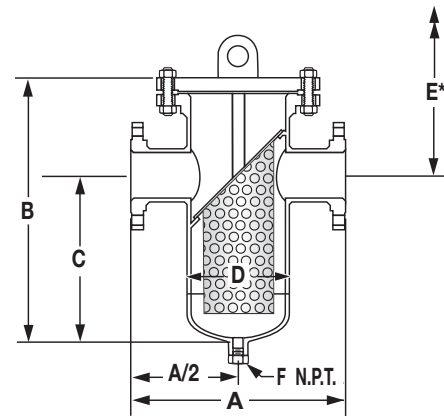

Standard cover is bolted.

Cover lifting lug standard on 10" sizes and larger.

Class 150# and 300# flanges are standard.

Class 600# and higher available on request.

*Distance required for basket removal.

Connections³: 2"– 20"
 RF, FF, RTJ Flanged or Buttweld

3. Larger sizes available. Consult Factory.
 For Buttweld connection please specify mating pipe schedule.

SCREEN OPENINGS

SIZE	STANDARD SCREEN	MATERIALS
2" – 12"	1/8 Perf.	304 SS
14" – 24"	3/16 Perf.	304 SS

FB3 DIMENSIONS inches (mm) AND WEIGHTS pounds (kg)

150# Class Flanges shown (For 300#, 600#, 900# and 1500# dimensions and weights, contact factory.)

Inlet	Body	A	B ⁴	C	D	E	F	Weight-150#	
								Cover	Unit
2 (50)	8 (200)	15 (381)	22¼ (565)	14 (356)	8½ (219)	25 ¹⁵ / ₁₆ (659)	½ (13)	45 (20)	135 (61)
3 (80)	10 (250)	22½ (575)	26½ (683)	15½ (403)	10¼ (273)	32½ (829)	½ (13)	70 (32)	150 (68)
4 (100)	10 (250)	22½ (575)	26½ (683)	15½ (403)	10¼ (273)	32½ (829)	½ (13)	70 (32)	160 (73)
6 (125)	12 (300)	25 (635)	32 (813)	21 (533)	12¼ (324)	37½ (943)	¾ (19)	110 (50)	300 (136)
8 (200)	14 (350)	28 (711)	37 (940)	23 (584)	14 (356)	44½ (1132)	1 (25)	139 (63)	520 (236)
10 (250)	18 (450)	36 (914)	47½ (1197)	30½ (772)	18 (457)	53 ¹ / ₁₆ (1364)	1½ (38)	220 (100)	1150 (523)
12 (300)	20 (500)	37 (940)	46¼ (1175)	31 (787)	20 (508)	52½ (1343)	1½ (38)	285 (129)	1500 (682)
14 (350)	24 (600)	42 (1067)	56½ (1426)	34½ (876)	24 (610)	66½ (1686)	1½ (38)	430 (195)	1850 (841)
16 (400)	30 (750)	52 (1321)	72½ (1842)	49 (1245)	30 (762)	82½ (2096)	2 (51)	965 (438)	2800 (1273)
18 (450)	30 (750)	52 (1321)	72½ (1842)	49 (1245)	30 (762)	82½ (2096)	2 (51)	965 (438)	3050 (1386)
20 (500)	36 (900)	64 (1626)	88½ (2251)	60 (1524)	36 (914)	99½ (2534)	2 (51)	1540 (699)	4000 (1909)

Dimensions shown are for reference only. Consult factory for certified prints when required.

* Consult factory.

4. Weight and dimensions with Bolted Cover.

FB4 SERIES FABRICATED BASKET STRAINERS

SPECIFICATION

Strainer shall be designed and manufactured to meet ASME B31.1, ASME B31.3 or ASME B31.4 and/or ASME Section VIII Div.1. The Strainer body shall be fabricated steel or other specified material and inlet/outlet connections shall be in line. The Strainer shall have a single pleated basket. The screen shall be size ____ perforated stainless steel. The Strainer shall have an inlet size of ____ and open area ratio of _____. The Basket Strainer shall be SSI FB4.

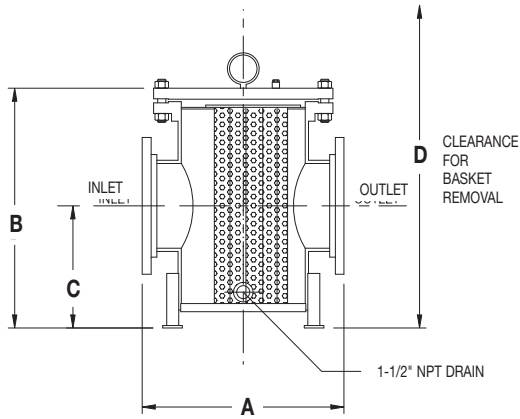

Standard Cover is bolted. Quick Opening Cover is available on request.
Cover lifting lug standard on bolted covers.
Class 125#/150# flanges standard.
Other Classes available on request.

Connections: 10"– 18" Flanged

SCREEN OPENINGS

SIZE	STANDARD SCREEN	MATERIALS
10" – 12"	1/8 Perf. Pleated	304 SS
14" – 18"	3/16 Perf. Pleated	304 SS

MATERIALS OF CONSTRUCTION (Carbon Steel Shown[†])

BodySA53S/B or SA106-B
NozzlesSA53S/B or SA106-B
FlangesSA105
HeadsSA234-WPB or SA516-70
CouplingsSA105
PlugSA105
Basket¹304 SS
Gasket¹304 SS Spiral Wound
StudSA193-B7
NutSA194-2H

[†] Other Materials Available. Consult factory.

¹. Recommended Spare Parts.

Material specification will change when NACE MR01-75 is specified.

FB4 DIMENSIONS inches (mm) and WEIGHTS pounds (kg)

For pressure classes greater than 150# consult factory.

Inlet/ Outlet	A	B	C	D	Weight	
					Cover ¹	Unit
10 (250)	23 (584)	29 (737)	12.19 (310)	47 (1194)	180 (82)	600 (272)
12 (300)	27 (686)	38 (965)	16.75 (425)	67 (1702)	220 (100)	1100 (499)
14 (350)	31 (787)	45 (1143)	18.75 (476)	77 (1956)	285 (129)	1300 (590)
16 (400)	31 (787)	45 (1143)	18.75 (476)	77 (1956)	430 (195)	1600 (726)
18 (450)	31 (787)	45 (1143)	18.75 (476)	77 (1956)	430 (195)	1800 (816)

Dimensions shown are for reference only. Consult factory for certified prints when required.

¹. Weight and dimensions with Bolted Cover.

FB5 SERIES FABRICATED BASKET STRAINERS

SPECIFICATION

Strainer shall be designed and manufactured to meet ASME B31.1, ASME B31.3 or ASME B31.4 and/or ASME Section VIII Div.1. The Strainer body shall be fabricated steel or other specified material and inlet/outlet connections shall be in line. The Strainer shall have four independent baskets. The screen shall be size ____ perforated stainless steel. The Strainer shall have an inlet size of ____ and open area ratio of _____. The Basket Strainer shall be SSI FB5.

MATERIALS OF CONSTRUCTION (Carbon Steel Shown†)

BodySA53S/B or SA106-B
 NozzlesSA53S/B or SA106-B
 FlangesSA105
 HeadsSA234-WPB or A516-70
 CouplingsSA105
 Plug.....SA105
 Basket¹304 SS
 Gasket¹Non Asbestos
 StudSA193-B7
 NutSA194-2H

† Other Materials Available. Consult factory.

1. Recommended Spare Parts.

Material specification will change when NACE MR01-75 is specified.

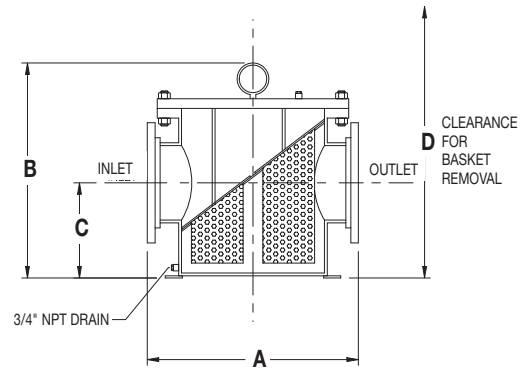

Standard cover is bolted.

Cover lifting lug standard on bolted covers.

Class 125#/150# flanges standard.

Class 300# available on request.

Connections: 8"– 36" Flanged

SCREEN OPENINGS

SIZE	STANDARD SCREEN	MATERIALS
8" – 12"	1/8 Perf.-multi basket	304 SS
14" – 36"	3/16 Perf.-multi basket	304 SS

FB5 DIMENSIONS inches (mm) and WEIGHTS pounds (kg)

For pressure classes greater than 150# consult factory.

Inlet/ Outlet	A	B	C	D	Weight	
					Cover ¹	Unit
8 (200)	23.35 (593)	20.13 (511)	9.13 (232)	38 (965)	180 (82)	750 (340)
10 (250)	26.13 (664)	23.75 (603)	11.38 (289)	44 (1118)	220 (100)	1100 (499)
12 (300)	29 (737)	28.38 (721)	14.63 (372)	52 (1321)	285 (129)	1500 (680)
14 (350)	30.5 (775)	31.25 (794)	16.75 (425)	60 (1524)	430 (195)	1900 (862)
16 (400)	33.5 (851)	35.5 (902)	19.13 (486)	66 (1676)	965 (438)	2400 (1089)
20 (500)	44.75 (1137)	46.25 (1175)	28.5 (724)	88 (2235)	1540 (699)	4500 (2041)
24 (600)	44.38 (1127)	52.25 (1327)	31.5 (800)	98 (2489)	1820 (826)	5900 (2676)
30 (750)	61.5 (1562)	66.5 (1689)	41.63 (1057)	125 (3175)	2240 (1016)	12100 (5489)
36 (900)	62 (1575)	66.5 (1689)	41.63 (1057)	125 (3175)	2240 (1016)	12400 (5625)

Dimensions shown are for reference only. Consult factory for certified prints when required.

1. Weight and dimensions with Bolted Cover.

FB SERIES

FABRICATED BASKET STRAINERS

PRESSURE DROP VS FLOW RATE

Water Service, Clean Basket, 1/32" - 1/4" Perforated Screen*

(Sizes 2" - 24")

FB1
FB2
FB3

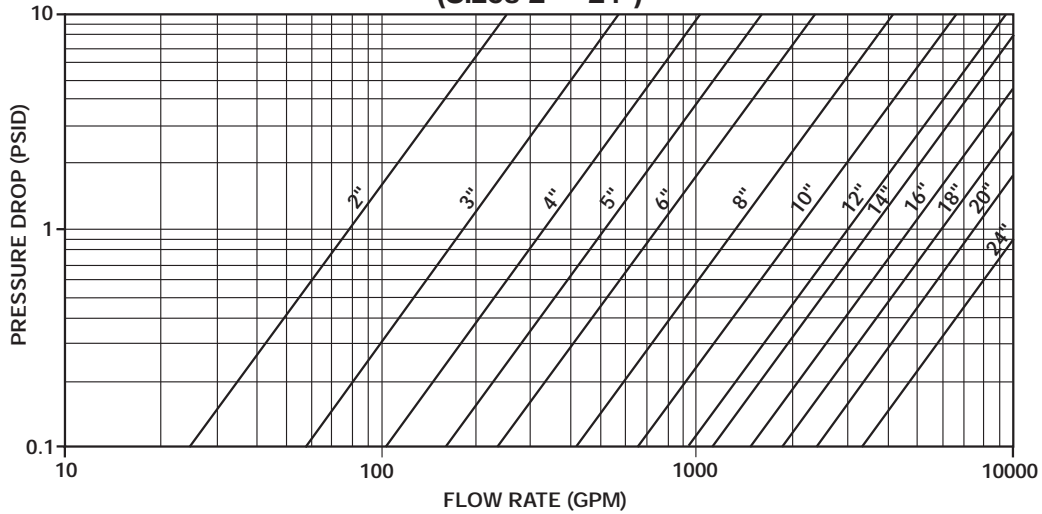

(Sizes 10" - 18")

FB4

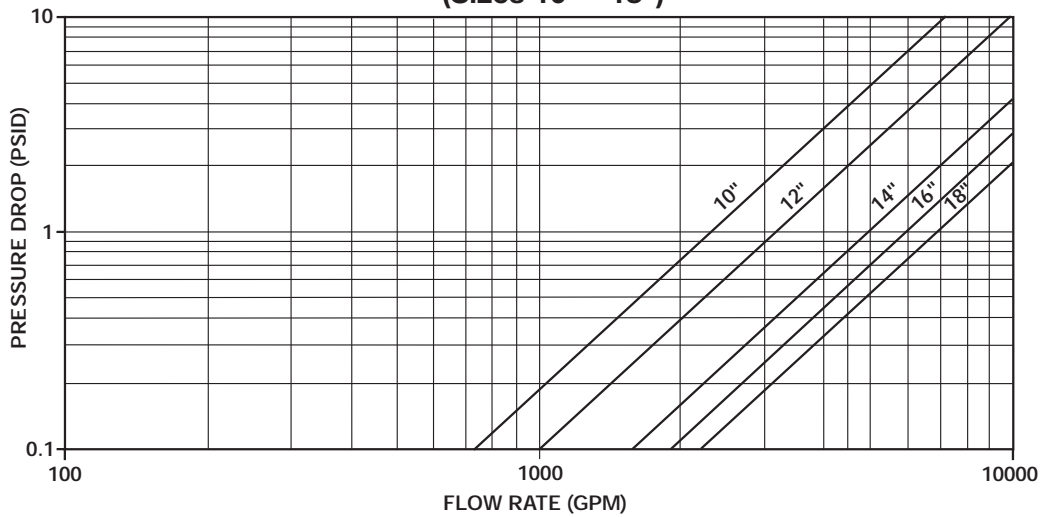

(Sizes 8" - 36")

FB5

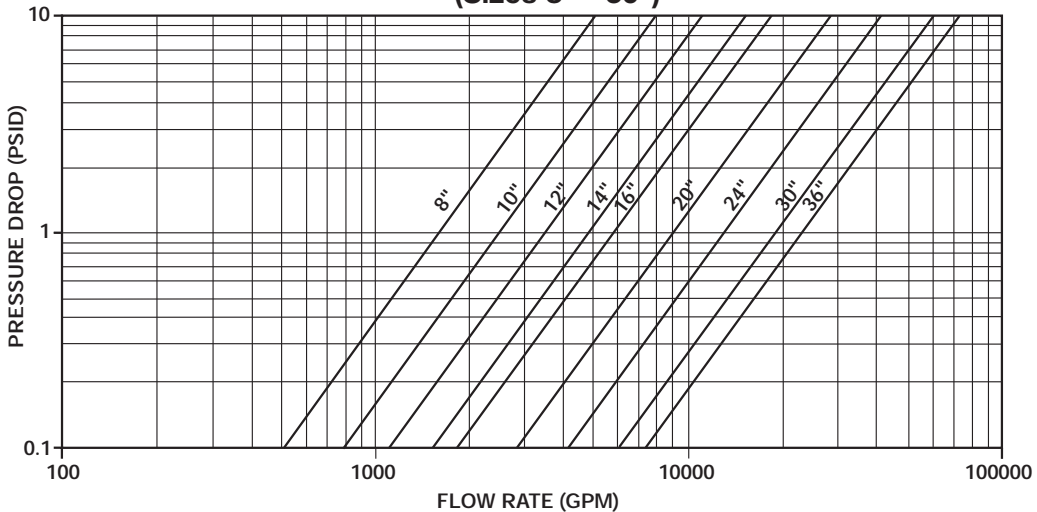

* For Gas, Steam or Air service, consult factory.

FB SERIES

FABRICATED BASKET STRAINERS

OPEN AREA RATIOS

FB1

Size	Opening diameter (in)	Opening %	Nominal Outlet Area (in ²)	Gross Screen Area (in ²)	Free Screen Area (in ²)	Open Area Ratio (OAR)
2	1/8	40%	3.36	171	68	20.3
3	1/8	40%	7.39	266	106	14.4
4	1/8	40%	12.73	266	106	8.4
6	1/8	40%	28.9	377	151	5.2
8	1/8	40%	50.0	562	225	4.5
10	1/8	40%	78.9	938	375	4.8
12	1/8	40%	113.1	1179	472	4.2
14	3/16	50%	137.9	1429	715	5.2
16	3/16	50%	176.7	1940	970	5.5
18	3/16	50%	227.0	2166	1083	4.8
20	3/16	50%	277.9	3393	1696	6.1
24	3/16	50%	402.0	5150	2575	6.4

FB2

Size	Opening diameter (in)	Opening %	Nominal Outlet Area (in ²)	Gross Screen Area (in ²)	Free Screen Area (in ²)	Open Area Ratio (OAR)
2	1/8	40%	3.4	78	31	9.3
3	1/8	40%	7.4	133	53	7.2
4	1/8	40%	12.7	133	53	4.2
6	1/8	40%	28.9	266	106	3.7
8	1/8	40%	50.0	451	180	3.6
10	1/8	40%	78.9	562	225	2.9
12	1/8	40%	113.1	703	281	2.5
14	3/16	50%	137.9	938	469	3.4
16	3/16	50%	182.7	1204	602	3.3
18	3/16	50%	227.0	1429	715	3.1
20	3/16	50%	291.0	1916	958	3.3
24	3/16	50%	402.0	3393	1696	4.2

FB3

Size	Opening diameter (in)	Opening %	Nominal Outlet Area (in ²)	Gross Screen Area (in ²)	Free Screen Area (in ²)	Open Area Ratio (OAR)
2	1/8	40%	3.4	266	106	31.7
3	1/8	40%	7.4	350	140	19.0
4	1/8	40%	12.7	350	140	11.0
6	1/8	40%	28.9	562	225	7.8
8	1/8	40%	50.0	762	305	6.1
10	1/8	40%	78.9	1179	472	6.0
12	1/8	40%	113.1	1338	535	4.7
14	3/16	50%	137.9	1916	958	6.9
16	3/16	50%	176.7	3393	1696	9.6
18	3/16	50%	227.0	3393	1696	7.5
20	3/16	50%	265.2	5150	2575	9.7

FB4







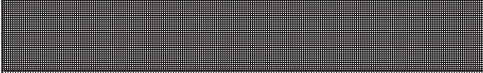
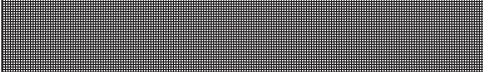
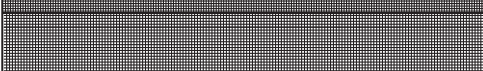
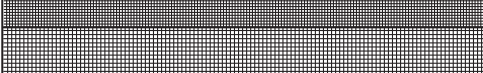
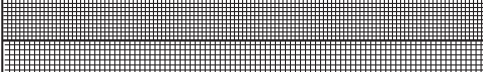
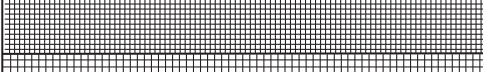
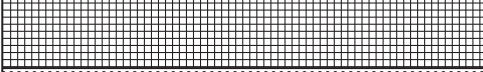
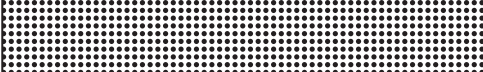

Size	Opening diameter (in)	Opening %	Nominal Outlet Area (in ²)	Gross Screen Area (in ²)	Free Screen Area (in ²)	Open Area Ratio (OAR)
10	1/8	40	78.85	800	320	4.1
12	1/8	40	113.1	1200	480	4.2
14	3/16	50	140.5	2000	1000	7.1
16	3/16	50	185.66	2000	1000	5.4
18	3/16	50	237.1	2000	1000	4.2

OAR = Free Screen Area / Nominal Inlet Area
 Free Screen Area = Opening % x Gross Screen Area
 Values shown are approximate. Consult factory for exact ratios.

Open Area Ratios can be larger with custom basket designs.
 Contact factory when required.

For FB5 Open Area Ratios, consult factory.

SCREEN OPENINGS

	100 Mesh - 30% O.A. 0.006" Openings
	80 Mesh - 36% O.A. 0.008" Openings
	60 Mesh - 38% O.A. 0.010" Openings
	40 Mesh - 41% O.A. 0.016" Openings
	30 Mesh - 45% O.A. 0.022" Openings
	20 Mesh - 49% O.A. 0.035" Openings
	0.027" Dia.- 23% O.A.
	0.033" Dia.- 28% O.A.
	3/64" Dia.- 36% O.A.
	1/16" Dia.- 37% O.A.
	3/32" Dia.- 39% O.A.
	1/8" Dia.- 40% O.A.
	5/32" Dia.- 58% O.A.
	3/16" Dia.- 50% O.A.
	1/4" Dia.- 40% O.A.

FACTORS TO CONSIDER

1 Purpose

If the strainer is being used for protection rather than direct filtration, standard screens will suffice in most applications.

2 Service

With services that require extremely sturdy screens, such as high pressure/temperature applications or services with high viscosities, perforated screens without mesh liners are recommended. If a mesh liner is required to obtain a certain level of filtration, then a trapped perf/mesh/perf combination is recommended.

3 Filtration Level

When choosing a perf. or a mesh/perf. combination, attention should be given to ensure overstraining does not occur. As a general rule, the specified level of filtration should be no smaller than half the size of the particle to be removed. If too fine a filtration is specified, the pressure drop through the strainer will increase very rapidly, possibly causing damage to the screen.

Screen openings other than those shown above are readily available. Various mesh sizes as fine as 5 micron and perforated plate as coarse as 1/2" Dia. are in inventory.

Screens are available in a wide range of materials. Screens of carbon steel, stainless steel (304, 316), alloy 20, monel 400, hastelloy C and titanium grade 2 are in inventory.

Custom manufactured screens are available upon request. Please consult factory.

FB SERIES

FABRICATED STRAINERS

QUICK OPENING COVERS AND COVER REMOVAL AIDS

The quick release covers and cover removal aids, available on fabricated strainers, are distinguished by their compact size and functional design. Materials of construction are in accordance with ASME specifications and manufacturing complies with the applicable rules of the ASME Code for Pressure Piping and with the ASME Boiler and Pressure Vessel Code.

COVER REMOVAL AID

COVER TYPE D - BOLTED WITH DAVIT ASSEMBLY

The Davit Assembly permits the user to swing the cover away to facilitate basket or screen removal for cleaning. It is used primarily for larger strainers where cover removal is difficult. The Davit Assembly is an inexpensive alternative to quick release covers, especially when operating conditions require a bolted cover.



QUICK OPENING COVERS



COVER TYPE H - T-BOLT HINGED COVER

The T-bolt Hinged Cover is the most economical quick opening closure we offer on fabricated strainers for nominal pressure applications. The T-bolt Hinged Cover utilizes an O-ring seal. It opens quickly and easily by loosening the T-bolts until they clear the holding lugs and swinging the head open on its hinge. Camlock and Break-over Wrench Assemblies that eliminate the need for a wrench are also available.

FB SERIES FABRICATED STRAINERS QUICK OPENING COVERS AND COVER REMOVAL AIDS

COVER TYPE Y - YOKE HINGED COVER

The Yoke Hinged Cover is a true ANSI rated closure that utilizes an O-ring seal. The Yoke Hinged Cover is used primarily on high pressure applications and is available with 150#, 300#, 600#, 900#, and 1500# ANSI ratings with a wide range of operating aids, ranging from a single lever chain and sprocket drive to completely automated.



COVER TYPE T - THREADED HINGED COVER

The Quick Opening Threaded Cover consists of a cap fastened to a hub welded to the strainer body. The female cap is threaded onto the male hub with an O-ring seal. This O-ring prevents corrosion of the closure threads, providing long, trouble free service. The Threaded Cover is for both nominal and high pressure applications.



GENERAL COMPARISON OF DIFFERENT CLOSURE TYPES

Comparison Item	Closure Type				
	Bolted Type B	w/Davit Type D	T-Bolt Type H	Bolted Yoke Type Y	Threaded Type T
Cost	Lowest	Low	Moderate	High	High
Quick Opening Ability	Poor	Fair	Good	Best	Best
Low Pressure Applications	X	X	X	—	—
Nominal Pressure Applications	X	X	X	X	X
High Pressure Applications	X	X	—	X	X

Standard O-Ring material BUNA-N (-30 to 250°F)
Standard O-Ring material Viton (-15 to 400°F)

BASKET STRAINERS

REPLACEMENT BASKET SCREENS

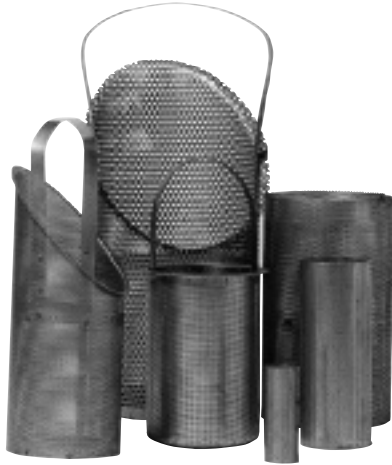

We have screens and baskets for all makes of Y, basket and duplex strainers. The range of materials and size of units is unlimited.

We provide baskets manufactured from:

- **Perforated Plate**
- **Mesh or Mesh/Perf. Combination**
- **Wedge Wire**
- **Laser Beam Small Hole Perforated Plate**

Using the above processes or combination thereof, we can provide screens and baskets suitable for a wide range of applications.

SCREEN/BASKET CHECKLIST

Kindly photocopy this page and fill out the pertinent information.

BASKET STRAINER STYLE "D"

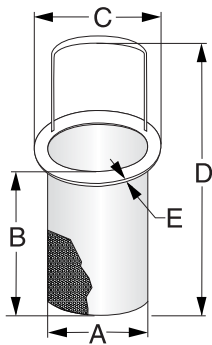

Performance Requirements

Description	Customers Requirement
Required Level of Filtration =	
Material of Construction =	
Minimum Specified Burst Pressure =	
Flow Direction =	
Other =	

BASKET STRAINER STYLE "B"

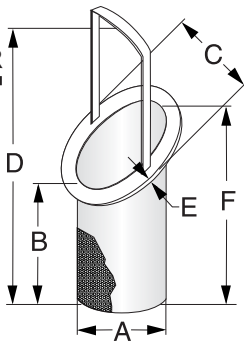

Dimensional Requirements

Description		Customers Requirement
Style	B or D	
Basket Outer Diameter	A =	
Basket Height	B =	
Ring OD	C =	
Overall Height	D =	
Ring Thickness	E =	
Basket Long Height	F =	

BASKET STRAINER

PRESSURE DROP CORRECTION FACTORS

Mesh Lined Baskets and/or Fluids with a Viscosity other than Water

Centistokes	SSU	Unlined Perforated Basket	20 Mesh Lined Basket	40 Mesh Lined Basket	60 Mesh Lined Basket	80 Mesh Lined Basket	100 Mesh Lined Basket	200 Mesh Lined Basket
2	30 (water)	1	1.05	1.2	1.4	1.6	1.7	2
100	500	1.6	1.7	1.9	2.1	2.4	2.6	3.1
216	1000	1.7	2	2.2	2.4	2.6	2.8	3.3
433	2000	1.9	2.2	2.4	2.7	2.9	3.2	3.8
650	3000	2	2.3	2.6	2.9	3.2	3.5	4.1
1083	5000	2.2	2.6	3	3.5	4	4.5	5.3
2200	10000	2.5	3	3.5	4.2	5	6	7.1

- 1) Obtain water pressure drop from graphs on appropriate product page.
- 2) Multiply the pressure drop obtained from (1) by the specific gravity of the liquid.
- 3) Multiply the pressure drop from (2) by the appropriate correction factor for the mesh liner and/or viscosity.

Example

Model: 150B1
Size: 4"
Filtration: 1/8" perforated screen
 40 Mesh lines
Flow rate: 200 GPM
Fluid: Water
SG: 1
Viscosity: 30 SSI

Answer

- A) From Pressure Drop Chart, pressure drop of water is .38 psid
- B) Multiply by specific gravity; $.38 \times 1 = .38$ psid
- C) From chart above, multiply $.38 \times 1.2$ (correction factor) = .456 psid

CORRECTION FACTORS FOR CLOGGED SCREENS

% Clogged	Ratio of Free Screen Area to Pipe Area						
	10:1	8:1	6:1	4:1	3:1	2:1	1:1
10							3.15
20						1.15	3.9
30						1.4	5
40						1.8	6.65
50					1.25	2.5	9.45
60				1.15	1.8	3.7	14.5
70				1.75	2.95	6.4	26
80		1.1	1.75	3.6	6.25	14	58
90	2.3	3.45	6	13.5	24	55	

* Multiply values obtained from Pressure Drop Charts by the appropriate values shown below.

Example

Strainer Size: 6"
Model: 150B1
Body: Carbon Steel
Filtration: 1/8" Perf.
Flow rate: 1000 GPM
Service: Water
% Clogged: 60%

Answer

- A) The Pressure Drop Chart indicates a drop of 1.50 psid with standard screen.
- B) The Effective Area Chart indicates a ratio of 2.5:1 free area to pipe area.
- C) Using Chart above we read the correction factor of 2.5:1 (2:1 approx.) to be 3.7 at 60% clogged.
- D) Total pressure drop equals $1.50 \times 3.7 = 5.55$ psid.

BASKET STRAINER

BURST PRESSURE

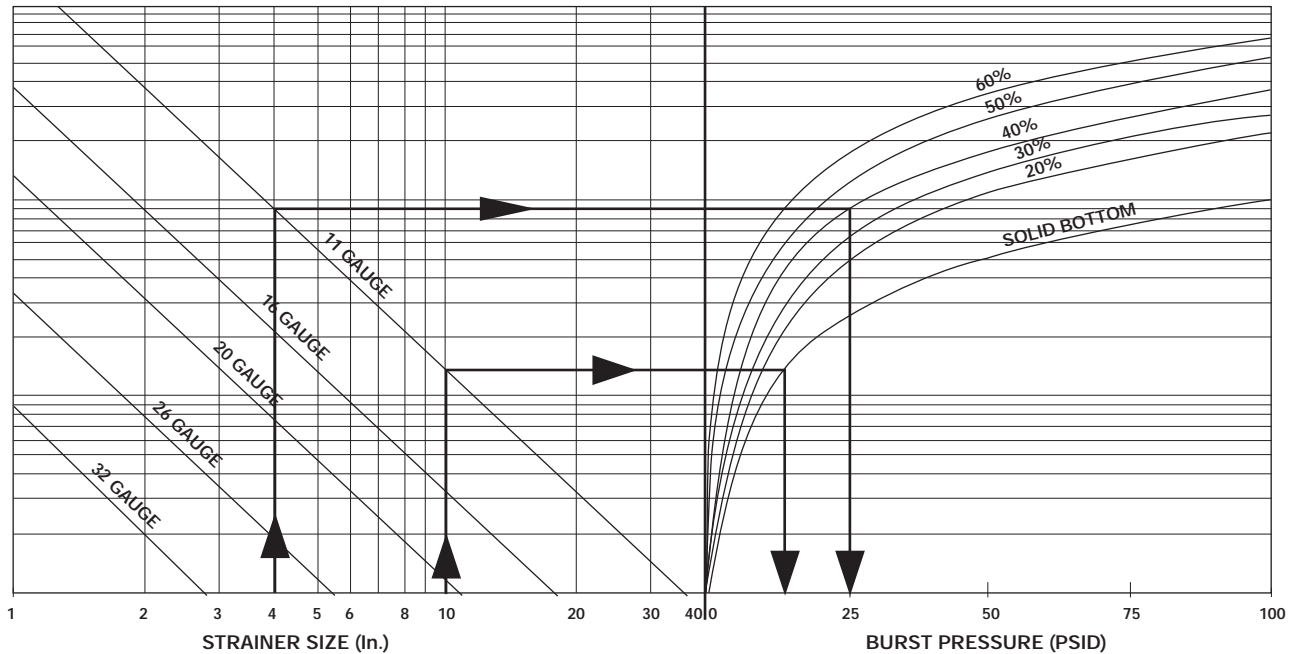

Baskets with perforated bottoms are standard.

Chart is based on standard dimensions. Higher burst pressure ratings are available. Please consult factory.

Chart is based on stainless steel screen material. No safety factor is incorporated. It is the responsibility of the user to determine an acceptable safety factor.

Example

Strainer Size: 10"

Basket Type: Perforated screen with 11 gauge solid flat bottom

Screen Material Open Area: 20% - 60%

Answer

- Locate Strainer size.
- Follow vertical line to solid thickness.
- Follow horizontal line to solid bottom curve.
- Follow vertical line downward to read burst pressure.
- Burst pressure equals 15 psid.

Source: ASME Section VIII, Div. 1, UG-34