



Professional Two-way Radio

SLX SERIES

User Guide



Go Beyond Normal Limits...™



SLX Custom Programmed Listing

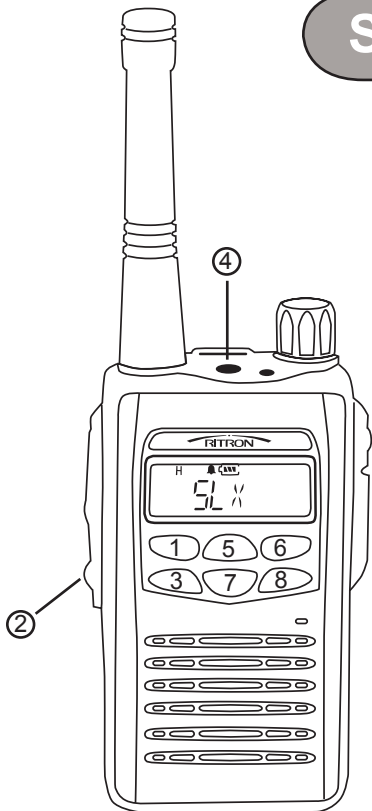

Button 1 _____

Button 2 _____

Button 3 _____

Button 4 _____

Button 5 _____

Button 6 _____

Button 7 _____

Button 8 _____

INCLUDED ITEMS

FCC APPROVAL

FCC ID: SLX-100
SLX-400

AIERIT21-150
AIERIT21-450



Two-way Radio



1800mAh Li-Ion
Battery Pack
with attached Belt Clip

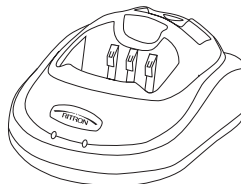

Desktop Stand with
110 VAC
Rapid Charger

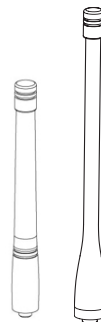

VHF or UHF
Antenna



User Manual

CONTENTS

Radio Overview	3	Programmable SLX Radio Features.....	13
Get Acquainted with your Radio's Controls	4	MENU Accessible Features.....	17
Display Icons	5	FCC Regulations	18
SLX Audio Accessories.....	6	Safety Standards.....	18
Attaching the Battery	8	Service.....	18
Removing the Battery.....	8	How To Obtain An FCC License	18
Dual Slot Charger	9	RF Energy Exposure Awareness and Control Information.....	19
Attaching the Antenna	10	Limited Warranty	21
ON/OFF and Volume Control	10	SLX Tone Codes Cross-reference Chart.....	22
Operating the Radio	11	SLX Antenna Cutting Chart	24
Programmable Function Buttons.....	12		
Using the MENU/ENTER Button	13		

RADIO OVERVIEW

Thank you for purchasing the RITRON 60-channel SLX Series business band two-way radio. Read all instructions carefully and completely before using your new two-way radio. This instruction manual contains important operating instructions for your radio.

Radio Controls

The numbers below refer to the illustrations on the next page.

1. On-Off / Volume Knob

Turn the power/volume control knob clockwise to turn the radio on.

2. Push to Talk Button (PTT)

Push and hold to transmit; release to listen.

3. Monitor Button

Press the Monitor button momentarily to disable the Tone squelch.

4. Emergency Button (Orange)

The emergency function allows you to transmit an emergency signal tone to other radios on your system. In addition, your SLX radio will show the word “EMERGENC” on the display.

Note: After the emergency tone is transmitted, the microphone on the sending radio will be active for 5 seconds (programmable). This allows the user of the transmitting radio to talk hands-free.

The emergency feature can be programmed to cycle from 1-15 times or continuously until it is manually re-set. See your Ritron dealer for custom settings.

5. TX (Red) and RX (Green) LED Indicator

6. Microphone

7. LCD Display (8 Character Alphanumeric)

8. 8 Programmable Function Buttons (PFB)

9. Antenna

10. Accessory Connector

Connects headsets, remote speaker/microphones and other accessories. Replace attached dust cap when not in use.

11. Spring Action Belt Clip

12. Speaker

Get acquainted with your radio's controls

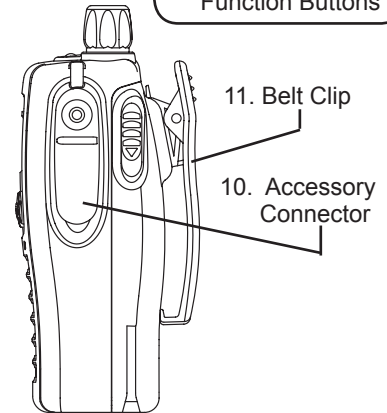
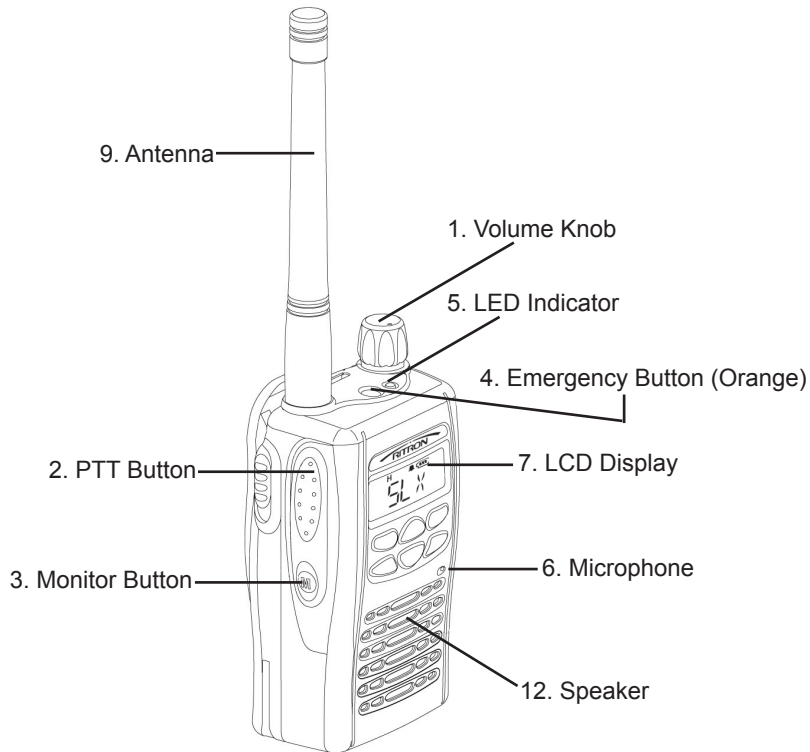

Display Icons

To provide additional feedback to the radio user, the LCD display has several status icons. Some status icons are “radio wide”. Other icons appear **only if** the feature is set to **ON** for the current operating channel.



Symbol	Name/Function
	<p>Signal Strength Indicator – shows received signal strength of an incoming call.</p> <p>Full circle = strong signal $\frac{3}{4}$ circle = moderate signal $\frac{1}{2}$ circle = acceptable signal $\frac{1}{4}$ circle = very weak signal</p>
	H/L - Indicates power (High or Low) setting of individual channel.
	Keypad Lock – Appears when keypad lock is ON.
	Bell – Appears when keypad tones are ON.

Symbol	Name/Function
	<p>Battery Level Indicator:</p> <p>3 Bars = full charge 2 bars = 66% 1 = bar 33%</p>
	“Hands-Free” VOX Indicator – Appears when Hands-Free feature is ON.
	Scan Indicator – Appears when Channel Scan is ON.
	Scrambler Indicator – Appears when Voice Scrambler is ON.
	Talk Around Indicator – Appears when radio is operating on the Talk Around channel.

SLX Audio Accessories

The Ritron offers a wide range of audio accessories and headsets to help customize your SLX radio for your application. All SLX audio accessories include a durable, injection molded strain relief. The strain relief keeps the audio accessory firmly attached to the SLX radio during use and attaches to the radio using 2 Phillips head screws (provided).

1. To attach audio accessory to the SLX radio- first remove the Phillips head screw holding the rubber dust cover in place. (see diagram below).
2. Remove the Phillips head screw on the inside bottom of the dust cover area.
3. Remove inner foam gasket.
4. Place these items in a secure place for future possible use.
5. Attach audio accessory to the SLX radio. (see diagram for proper position of strain relief). Cord leading to the headset or speaker mic of the accessory must be directed toward the top of the radio.
6. Do NOT over-tighten or apply excessive force when securing Phillips heads screws. Snug top and bottom screws down to the molded strain relief.

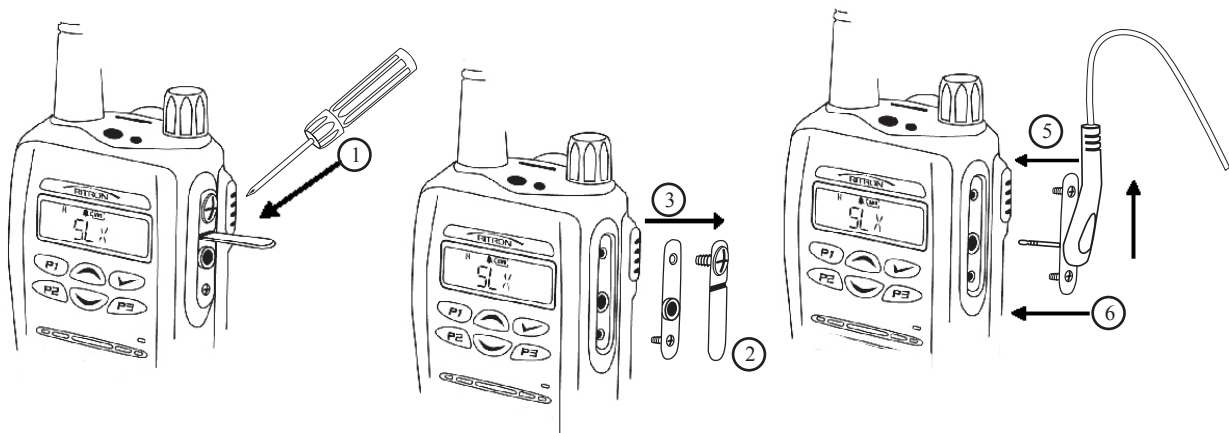

SLX Audio Accessories (cont...)

RSM-5Xa Remote Speaker Microphone with rotating spring action clip
Speaker/mic can be attached to clothing close to mouth and ears allowing easier communication without removing radio from belt.

RHD-10X Earbud w/ pendant PTT with built-in microphone and clip.
Enables private listening and great for noisy environments. Mic with PTT can be attached to clothing for easy activation.

RHD-11X Security type earpiece with pendant PTT with built-in microphone and clip.
Allows private listening and remote PTT for applications requiring more discrete communications.

RHD-12X Lightweight behind-the-head headset with boom mic and pendant PTT.
Great for noisy environments! Single ear headset with boom mic and in-line PTT.

LH-D Leather carry holster with swivel belt loop

DS-CB Swivel attachment, fits LH-D Leather Holster

NH-C Nylon Carry Holster with Fixed Metal Belt Clip

BC-G6X/J 6-unit 110/220 VAC, 12 VDC Charger (SLX and J Series only)

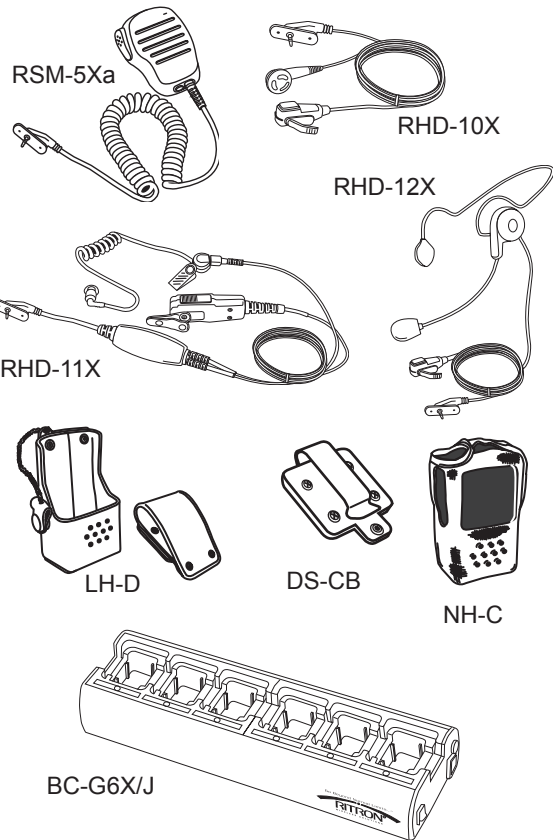

Attaching the Battery

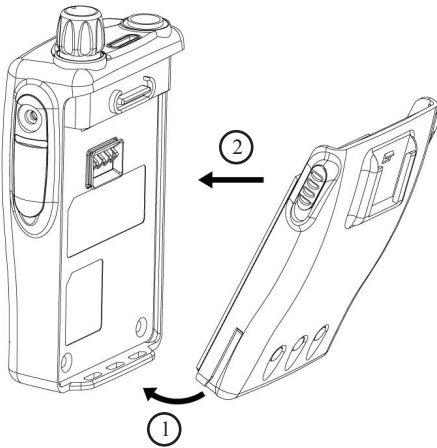

1. Fit the tabs at the bottom of the battery into the slots at the bottom of the radio's body.
2. Press the top part of the battery towards the radio until both latches firmly attach to the radio.

Removing the battery

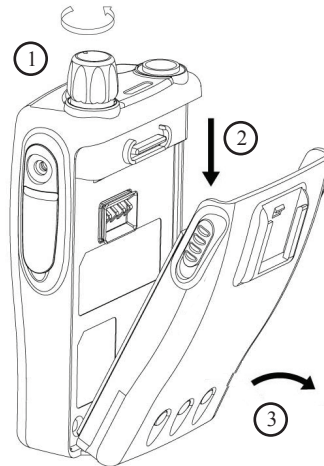

1. Turn off the radio.
2. Slide the latches located on both sides of the battery downwards at the same time.
3. Pull the top part of the battery away from the radio's body, and remove the battery.

Dual Slot Charger

The enclosed dual slot charger can charge two batteries sequentially. The front slot must be complete (green) before charging the 2nd slot. **Note: Charge battery before use!**

A completely discharged pack will be recharged in approximately 2.5 hours.

Place spare battery pack in slot with label facing forward

Place radio with attached battery pack or battery pack only (see slots for battery only)

- * Use only a Ritron approved 110 VAC Adapter.
- * Do not attempt to repair.
- * Do not attempt to charge any other brand of battery!
- * Do not expose to rain, snow, or moisture.
- * Do not use an extension cord to run power to the charger.

<u>LED</u>	<u>Status</u>
Red	Charging
Green	Complete
Amber	Waiting

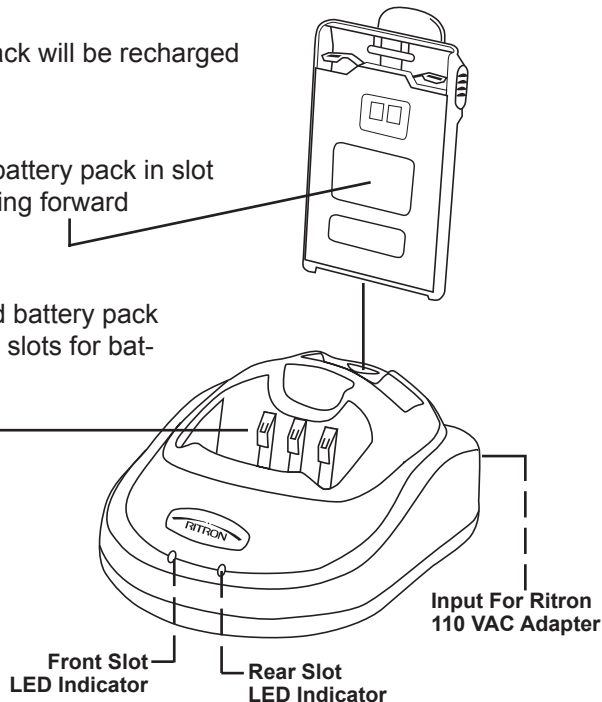

Attaching the Antenna

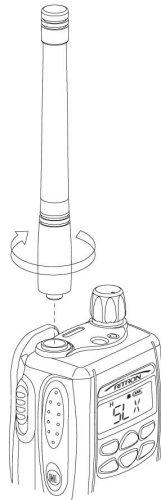

1. Align the threaded end of the antenna with the radio's antenna connector.
2. Turn the antenna clockwise to attach to the radio.

NOTE: * Do not use radio or activate transmitter unless antenna is securely fastened to radio.
* Do not use any portable radio that has a damaged antenna.

ON/OFF and Volume Control



1. To turn the radio ON, turn the knob clockwise. To turn the radio OFF, turn the knob counter clockwise.
2. To adjust volume UP, turn the knob clockwise. To turn the volume DOWN, turn the knob counter clockwise.

Operating the Radio

This radio offers up to 60 channels.

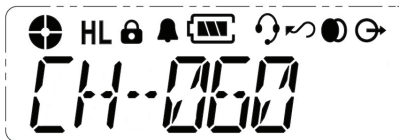

- Select the desired channel by using the Up/Down button. When held down, channels change continuously.
- To check channel activity, press the monitor button.
- To talk **press and hold** the PTT button. **Speak** into the microphone on the radio. **Release to listen**.

Note: For maximum clarity hold the radio 2-3 inches away from your mouth and speak in a normal tone of voice.

Sending an Emergency Call

The Emergency feature button allows the radio user to send an Emergency Call to all other radios programmed on the channel. For example, if the radio user should become injured, trapped or is in danger, a simple push (HOLD for 2 seconds) of the orange button will activate the Emergency function. The Emergency function is programmable, it includes:

- Press and HOLD Orange button for 2 seconds, the word “EMERGENC” will be displayed on the radio display. Alert tone sounds on “sending” radio speaker.



- Radio sends the alert tone to other radios with the same frequency and tone. If the “receiving” radio is an SLX it will display the word “EMERGENC” on its display.
- After alert tone sounds, “sending” radio’s transmitter is “keyed” for a specified period of time (**factory default 5 seconds**). This allows any audio present at the “sending” radio to be transmitted “hands free” to all other radios on the system (e.g. a call for help, the location and/or name of the person in need, reason for Emergency).
- The Emergency function “cycle” can be programmed to repeat a number of times (**factory default 2 times**). See your dealer for details.
- To cancel the Emergency cycle at anytime: Press the orange button momentarily.

Sending a Page, Call Tone, or GateGuard Command Code

- Press the P2 button (**factory default**). The pre-programmed Contact List will appear in the radio display.
- Using the scroll up/down arrows select the desired name in the list.
- Press the PTT button momentarily and the code associated with the name will be automatically transmitted.

Programmable Function Buttons (PFB's)







Programmable Function Buttons (PFB) provide easy, one-button access to a specific feature/function. Your dealer can program the PFB to have: no function when pressed, toggle ON or OFF a specific feature, transmit a Call Tone or a variety of other features/functions (see complete list starting on page 13). The following table indicates the **Factory Default** setting for each of the PFB's on your radio.

<u>PF Button</u>	<u>Function</u>	<u>Description of Function</u>
Orange (top)	Emergency	Begins Emergency Cycle. Transmits assigned Emergency Call to other radios, transmitter keys for programmed period of time (5 seconds) to allow hands-free operation by sender. Cycle repeats 2 times.
Monitor (left side)	Monitor	If radio is programmed with sub-tone, momentarily press the Monitor button to toggle between sub-tone, no sub-tone or open squelch (you will hear squelch noise).
P1	TX Pwr Level	Transmitter toggles between high power (UHF 4W/VHF 5W) and low power (1W). H=High, L=Low pwr.
P2	Contact List	Allows access to pre-programmed Contact List . User can scroll contact list and/or transmit selective signaling codes e.g. <i>GateGuard command codes, 2-Tone codes, DTMF strings, Call Tones</i> .
P3	Scan	Radio will begin to scan designated channels. A channel must be flagged using PC programmer in order to be included in scan list. <i>Scan symbol will appear in display.</i>
	Scroll Up	Scroll channels or feature sub-list.
	Scroll Down	Scroll channels or feature sub-list.
	MENU/ENTER	Allows access to MENU enabled features and/or ENTER key.

Using The MENU/ENTER Button

Using the SLX special PC programming software your dealer can enable or disable access to certain features from the radio MENU button. Listed below are instructions for accessing these feature/functions from the radio MENU button. The MENU/ENTER  button can also be assigned to have no function when pressed.

To access feature/functions via the radio MENU:

- Press , if enabled, the first feature/function in the list will appear on the LCD display
- Use   to scroll to a specific feature/function or
- Press  to ENTER the feature/function appearing on the LCD display
- Use   to scroll sub-list option settings for the specific feature/function
- Press  to SAVE selection and exit MENU
- The last channel of operation will appear on the LCD display

Programmable SLX Radio Features

Your dealer can enable or disable access to the following features/functions. Listed below is a description of each. The grid on the right indicates if the feature can be: (1) Assigned to a specific programmable function button, and/or (2) If the function can be programmed to be accessible via the radio's MENU mode. Ask your dealer for details on the specific operation of these functions.

	PF Button Assignable	Menu Accessible
No Function Assigned For most basic applications and ease-of-use. If enabled, the PF button will have no function when pressed.	YES	No
Menu Button Activates the radio menu feature, menu selections will appear on the display.	YES	No
Up/Down Scroll Buttons Scroll Up/Down any selection list. This includes channel list, menu list, contact list, status list, RX or TX tone list, and variable level settings.	YES	No
Monitor/Call Cancel Will toggle sequentially between: tone, carrier, and open squelch mode, or will clear the display of any incoming call.	YES	No

Programmable SLX Radio Features (cont....)

	PF Button Assignable	Menu Accessible
Emergency Call Allows user to send an Emergency Call/Message on a pre-defined channel to other radios. Ex: If radio user should become injured, or is in danger. A push of the orange button activates the Emergency Call function. Ask your dealer for on specific details and operation of this feature.	YES	No
Backlight ON/OFF Turns the display backlight On or Off.	YES	No
Send A Selective Signaling Call, 1 - 4 Sends 2-tone Page e.g. GateGuard\Command code, 5-Tone Page, DTMF ANI numbers on a per channel basis.	YES	No
Send A Call Tone You can transmit a Call Tone to other radios in your group to alert them that you are about to talk. Radio transmits alternating tones for as long as the programmable function button is pressed.	YES	No
Group Select When programmed to a programmable function button, allows quick access to a group of up to 10 pre-programmed channels.	YES	YES
Go To A Fix (Pre-Set) Channel #, 1 - 4 "Speed dial" for quickly accessing pre-programmed channel(s). Eliminates the need to scroll through channels. A programmable function button can be assigned to 1 of up to 4 pre-set channels.	YES	No
Keypad Lock ON/OFF Prevents accidental activation of the front panel buttons. Icon appears on LCD display when ON.	YES	YES
Alerts ON/OFF Turn keypad tones OFF for silent operation. Icon will appear on LCD display when ON.	YES	YES
Send DTMF Digits Radio can be programmed by your dealer to transmit unique DTMF digits on a per channel basis and/or via programmable function button.	YES	No
Normal Scan ON/OFF Must be programmed by your dealer. Channels must be flagged as eligible scan channels. Normal Scan will periodically check these channels to prevent missed calls. Programmable function button can be set to turn function ON or OFF. Icon will appear on LCD display when scan is ON.	YES	YES
Talk Around ON/OFF Causes the radio to transmit on the receive frequency on channels where the RX and TX are not the same. Icon will appear on the LCD Display when ON.	YES	YES

Programmable SLX Radio Features (cont....)

	PF Button Assignable	Menu Accessible
Tx/Rx Tone Select Select CTCSS or DCS encode and decode tone codes on the current operating channel.	YES	YES
TX Power Level Set transmit power to high, medium or low on current operating channel. Icon (H or L) will appear on LCD display.	YES	YES
Battery Saver ON/OFF When ON, battery life is extended.	YES	YES
Missed Call Displays a list of missed Selcall calls.	YES	YES
Contact List Select and send from a list of pre-programmed encode codes. E.g. 2-Tone GateGuard Command codes to open different gates, turn on lights, pump control etc.	YES	YES
Status List Select and send from a list of pre-programmed "status" messages. E.g. Text messaging.	YES	YES
Voice Scrambler ON/OFF Provides added security and privacy. When ON, voice transmissions are scrambled. Can be programmed on a channel-by-channel basis. Icon will appear on LCD display when ON.	YES	YES
Squelch Level Will display the current squelch level and allow the user to raise or lower squelch with the Up and Down buttons. Smaller numbers increase squelch sensitivity, allowing the radio to hear weak and distant signals. Larger numbers decreases sensitivity, only strong, quiet signals are heard.	YES	YES
Password Prevents unauthorized use of the radio. At radio turn on user must enter 4 character password before radio will operate. Password is entered using the Up/Down scroll buttons and MENU button.	YES	YES
Priority Scan ON/OFF Must be enabled by your dealer. Designates a priority channel that is checked more frequently than other channels to prevent missed calls.	YES	YES
"Hands-Free" VOX ON/OFF Allows "hands-free" use of the radio, without an audio accessory (I.e. a headset). Icon will appear on LCD display when ON.	YES	YES
Priority Scan Channel Allows the user to set the priority channel from a list of available channels.	No	YES

Programmable SLX Radio Features (cont....)

	PF Button Assignable	Menu Accessible
VOX Level Allows user to select the voice audio level required to “key” the transmitter. VOX Level can be set from 0-15. A higher number makes the VOX circuit “MORE” sensitive (“less” audio is required) to trigger VOX operation. A lower number makes the VOX circuit “LESS” sensitive (“more” audio is required).	No	YES
Ear PTT ON/OFF Enables or disables microphone on radio. Allows use of earbud (listen only) device while microphone on radio remains enabled.	No	YES
Missed Call List Delete Clears the Missed Call List.	No	YES
Missed Call Send Will automatically send the current Status message if a Missed Call is detected.	No	YES
LED Indicator ON/OFF LED on top of the radio can be set to “blink” green every 10 seconds.	No	YES
Lone Worker Useful in situations where the radio user works alone and is either required to or it would be helpful to check in at regular intervals. SLX radio can be programmed to sound a tone to remind the Lone Worker that they must “call in”. If they do not call in within the specified period, radio will automatically send the Emergency code.	No	YES
Radio Reset See your Dealer for details	No	YES
Caller/Group ID Each transmission (16 possible codes) is uniquely identified. Receiving radios show name of caller/group on LCD display.	No	No
Selcall (Selective Calling) 2-Way Paging Selcall is a voice call to a specific radio or group of radios. The caller selects the radio or group of radios from a pre-programmed “contact list.”	No	YES
Status Messaging Send and receive pre-programmed alpha/numeric status messages.____	No	YES
[Ack]nowledge Sending radio receives an [Ack]nowledge message confirming that the Selcall or Status Message has been received.	No	No

MENU Navigation Chart

This chart shows the order of all MENU Accessible features. To be accessible from the radio's MENU they must first be "Enabled" using the PC programming software. The  button is the **Factory Default** for the MENU selection function. See page 12 for the **Factory Default** settings for each PF Button.

Note: Not all features are "Enabled" from the factory.

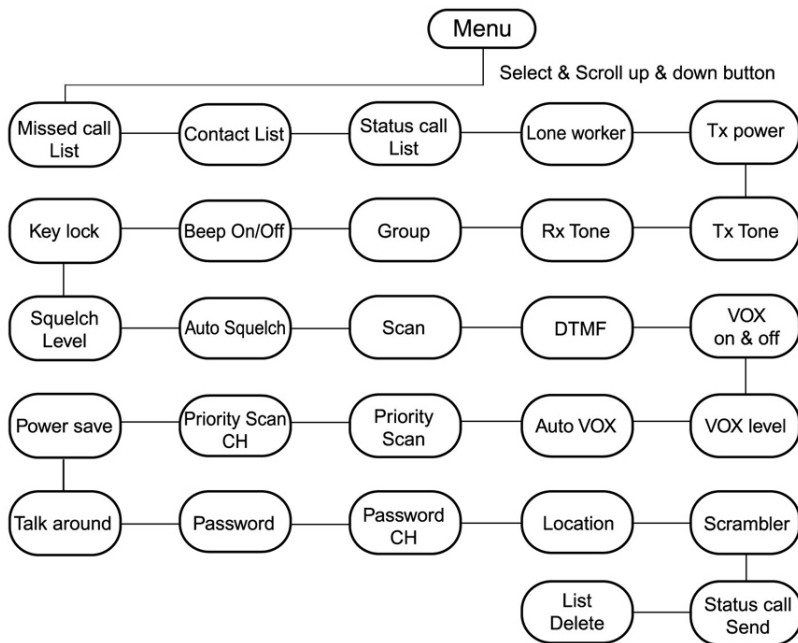

FCC REGULATIONS

LICENSING —The FCC requires the owners of **SLX Series** radios to obtain a station license before using them.

The station licensee is responsible for ensuring that transmitter power, frequency and deviation are within the limits specified by the station license. The station licensee is also responsible for proper operation and maintenance of the radio equipment. This includes checking the transmitter frequency and deviation periodically, using appropriate methods.

To get a FCC license for VHF or UHF frequencies, submit FCC application Form 600 as indicated in the block at right. Your Ritron dealer can help you with this process.

SAFETY STANDARDS —The FCC has adopted a safety standard for RF energy exposure awareness and control information, and operational instructions for FCC occupational use requirements. Refer to page 20 for complete details.

Service - Federal law prohibits you from making any internal adjustments to the transmitter, and/ or from changing transmit frequencies unless you are specifically designated by the licensee.

If your radio equipment fails to operate properly, or you wish to have the radio programmed, contact your authorized dealer or Ritron.

RITRON, INC., Repair Department
P. O. Box 1998
Carmel, IN 46082-1998 USA
Phone: 317-846-1201
FAX: 317-846-4978

HOW TO OBTAIN AN FCC RADIO LICENSE

Federal Communications Commission (FCC)
Licensing Information

Because your Ritron radio operates on Private Land Mobile frequencies, it is subject to the Rules and Regulations of the FCC, which requires all operators of these frequencies to obtain a station license before operating their equipment. Make application for your FCC license on FCC Forms 600 and 159.

*To have forms and instructions faxed to you by the FCC, call the **FCC Fax-On-Demand** system at **202-418-0177** from your fax machine; request Document 000600 & Form 159.*

*To have Document 000600 & Form 159 mailed to you, call the **FCC Forms Hotline** at **800-418-FORM** (800-418-3676).*

*For help with questions concerning the license application, contact the FCC at **888-CALL-FCC** (888-225-5322).*

You must decide which radio frequency(ies) you can operate on before filling out your application; refer to Table 1 on page 15 of this manual.

*For help determining your frequencies, call Ritron at **800-USA-1-USA** (800-872-1872).*

RF ENERGY EXPOSURE AWARENESS AND CONTROL INFORMATION, AND OPERATIONAL INSTRUCTIONS FOR FCC OCCUPATIONAL USE REQUIREMENTS

BEFORE USING YOUR PORTABLE 2-WAY RADIO, READ THIS IMPORTANT RF ENERGY AWARENESS AND CONTROL INFORMATION AND OPERATIONAL INSTRUCTIONS TO ENSURE COMPLIANCE WITH THE FCC'S RF EXPOSURE GUIDELINES.

NOTICE: This radio is intended for use in occupational/controlled conditions, where users have full knowledge of their exposure and can exercise control over their exposure to meet FCC limits. This radio device is NOT authorized for general population, consumer, or any other use.

This 2-way radio uses electromagnetic energy in the radio frequency (RF) spectrum to provide communications between two or more users over a distance. It uses radio frequency (RF) energy or radio waves to send and receive calls. RF energy is one form of electromagnetic energy. Other forms include, but are not limited to, electric power, sunlight and x-rays. RF energy, however, should not be confused with these other forms of electromagnetic energy, which when used improperly can cause biological damage.

Very high levels of x-rays, for example, can damage tissues and genetic material.

Experts in science, engineering, medicine, health and industry work with organizations to develop standards for exposure to RF energy. These standards provide recommended levels of RF exposure for both workers and the general public. These recommended RF exposure levels include substantial margins of protection. All 2-way radios marketed in North America are designed, manufactured and tested to ensure they meet government established RF exposure levels. In addition, manufacturers also recommend specific operating instructions to users of 2-way radios. These instructions are important because they inform users about RF energy exposure and provide simple

procedures on how to control it. Please refer to the following websites for more information on what RF energy exposure is and how to control your exposure to assure compliance with established RF exposure limits.

<http://www.fcc.gov/oet/rfsafety/rf-faqs.html>

<http://www.osha.gov/SLTC/radiofrequencyradiation/index.html>

FEDERAL COMMUNICATIONS COMMISSION REGULATIONS

The FCC rules require manufacturers to comply with the FCC RF energy exposure limits for portable 2-way radios before they can be marketed in the U.S. When 2-way radios are used as a consequence of employment, the FCC requires users to be fully aware of and able to control their exposure to meet occupational requirements. Exposure awareness can be facilitated by the use of a product label directing users to specific user awareness information. Your Ritron J Series 2-way radio has an RF exposure product label. Also, this user manual includes information and operating instructions required to control your RF exposure and to satisfy compliance requirements. (See following page)

COMPLIANCE WITH RF EXPOSURE STANDARDS

Your Ritron **SLX Series** 2-way radio is designed and tested to comply with a number of national and international standards and guidelines (listed below) for human exposure to radio frequency electromagnetic energy. This radio complies with the IEEE and ICNIRP exposure limits for occupational/controlled RF exposure environment at operating duty factors of up to 50% transmitting and is authorized by the FCC for occupational use only. In terms of measuring RF energy for compliance with the FCC exposure guidelines, your radio radiates measurable RF energy only while it is transmitting (during talking), not when it is receiving (listening) or in standby mode.

NOTE: The approved batteries supplied with this radio are rated for a 5-5-90 duty factor (5% talk-5% listen - 90% standby), even though this radio complies with the FCC occupational RF exposure limits and may operate at duty factors of up to 50% talk.

Your Ritron **SLX Series** 2-way radio complies with the following RF energy exposure standards and guidelines:

- United States Federal Communications Commission, Code of Federal Regulations; 47 CFR §§ 1.1307, 1.1310, 2.1091 and 2.1093
- American National Standards Institute (ANSI) / Institute of Electrical and Electronic Engineers (IEEE) C95.1-1992
- Institute of Electrical and Electronic Engineers (IEEE) C95.1-1999 Edition

RF EXPOSURE COMPLIANCE AND CONTROL GUIDELINES AND OPERATING INSTRUCTIONS

To control your exposure and ensure compliance with the occupational/controlled environment exposure limits always adhere to the following procedures.

GUIDELINES:

- Do not remove the RF Exposure Label from the device.
- This user manual should accompany device when transferred to other users.
- Do not use this device if the operational requirements described herein are not met.

OPERATING INSTRUCTIONS:

- Transmit no more than the rated duty factor of 50% of the time. To transmit (talk), push the Push-To-Talk (PTT) button. To receive calls, release the PTT button. Transmitting 50% of the time, or less, is important because this radio generates measurable RF energy exposure only when transmitting (in terms of measuring for standards compliance).
- Hold the radio in a vertical position in front of face with the microphone (and the other parts of the radio, including the antenna) at least one inch (2.5 cm) away from the nose. Keeping the radio at the proper distance is important because RF exposures decrease with distance from the antenna. Antenna should be kept away from eyes.

- When worn on the body, always place the radio in a Ritron approved clip, holder, holster, case, or body harness for this product. Using approved body-worn accessories is important because the use of Ritron or other manufacturer's non-approved accessories may result in exposure levels, which exceed the FCC's occupational/controlled environment RF exposure limits.
- If you are not using a body-worn accessory and are not using the radio in the intended use position in front of the face, then ensure the antenna and the radio are kept at least 2.5 cm (one inch) from the body when transmitting. Keeping the radio at the proper distance is important because RF exposures decrease with increasing distance from the antenna.
- Use only Ritron approved supplied or replacement antennas, batteries, and accessories. Use of non- Ritron approved antennas, batteries, and accessories may exceed the FCC RF exposure guidelines.
- For a list of Ritron approved accessories see this user manual, or visit <http://www.ritron.com>, or call Ritron at 800-872-1872.

CONTACT INFORMATION

For additional information on exposure requirements or other information, contact Ritron at 800-872-1872.

RITRON, INC. LIMITED WARRANTY

WHAT THIS WARRANTY COVERS: RITRON, INC. ("RITRON") provides the following warranty against defects in materials and/or workmanship in / under normal use and service during the applicable warranty period, as stated below. "Accessories" means antennas, holsters, chargers, earphones, speaker/microphones, and items contained in the programming and programming/service kits. Rechargeable batteries will be replaced during the applicable warranty period only if leakage occurs or the batteries drop below 75% of rated capacity.

<u>WHAT IS COVERED</u>	<u>FOR HOW LONG</u>	<u>WHAT RITRON WILL DO</u>
SLX Portable Radio	1 year*	During the first year after date of purchase, RITRON will repair or replace the defective product, at RITRON's option, parts and labor included at no charge.
Ritron Rechargeable Batteries	1 year *	Ritron will replace the defective battery.
Accessories	90 days*	<i>* After date of purchase</i>

WHAT THIS WARRANTY DOES NOT COVER:

- Any technical information provided with the covered product or any other products;
- Installation, maintenance or service of the product, unless this is covered by a separate written agreement with RITRON;
- Any products not furnished by RITRON which are attached or used with the covered product, or defects or damage from the use of the covered product with equipment that is not covered;
- Defects or damage, including broken antennas, resulting from:
 - misuse, abuse, improper maintenance, alteration, modification, neglect, accident or act of God, or,
 - the use of covered products other than in normal and customary manner, or,
 - improper testing or installation;
- Defects or damages from unauthorized disassembly, repair or modification, or where unauthorized disassembly, repair or modification prevents inspection and testing necessary to validate warranty claims;
- Defects or damages in which the serial number has been removed, altered or defaced.

IMPORTANT: This warranty sets forth the full extent of RITRON's express responsibilities regarding the covered products, and is given in lieu of all other

express warranties. What RITRON has agreed to do above is your sole and exclusive remedy. No person is authorized to make any other warranty to you on behalf of RITRON. Warranties implied by state law, such as implied warranties of merchantability and fitness for a particular purpose, are limited to the duration of this limited warranty as it applies to the covered product. Incidental and consequential damages are not recoverable under this warranty (this includes loss of use or time, inconvenience, business interruption, commercial loss, lost profits or savings). **Some states do not allow the exclusion or limitation of incidental or consequential damages, or limitation on how long an implied warranty lasts, so the above limitations or exclusions may not apply to you. Because each covered product system is unique, RITRON disclaims liability for range, coverage, or operation of the system as a whole under this warranty.**

WHO IS COVERED BY THIS WARRANTY: This warranty is given only to the purchaser or lessee of covered products when acquired for use, not resale. This warranty is not assignable or transferable.

HOW TO GET WARRANTY SERVICE: To receive warranty service, you must deliver or send the defective product, delivery costs and insurance prepaid, within the applicable warranty period, to RITRON, INC., 505 West Carmel Drive, Carmel, Indiana 46032, Attention: Warranty Department. Please point out the nature of the defect in as much detail as you can. **You MUST retain your sales or lease receipt (or other written evidence of the date of purchase) and deliver it along with the product.** If RITRON chooses to repair or replace a defective product, RITRON may replace the product or any part or component with reconditioned product, parts or components. Replacements are covered for the balance of the original applicable warranty period. All replaced covered products, parts or components become RITRON's property.

RIGHTS TO SOFTWARE RETAINED: Title and all rights or licenses to patents, copyrights, trademarks and trade secrets in any RITRON software contained in covered products are and shall remain in RITRON. RITRON nevertheless grants you a limited non-exclusive, transferable right to use the RITRON software only in conjunction with covered products. No other license or right to the RITRON software is granted or permitted.

YOUR RIGHTS UNDER STATE LAW: This warranty gives you specific legal rights, and you may also have other rights which vary from state to state.

WHERE THIS WARRANTY IS VALID: This warranty is valid only within the United States, the District of Columbia and Puerto Rico.

SLX Tone Codes Cross-reference Charts

Std QC Freq (Hz)	Ritron QC Code	SLX QC Code	Std QC Freq (Hz)	Ritron QC Code	SLX QC Code	Digital Code	Ritron Digital Code	SLX Digital Code
No Tone	44	0	192.8	31	31			
67.0	01	1	203.5	32	32	023	023	101
71.9	02	2	210.7	33	33	025	025	102
74.4	03	3	218.1	34	34	026	026	103
77.0	04	4	225.7	35	35	031	031	104
79.7	05	5	233.6	36	36	032	032	105
82.5	06	6	241.8	37	37	036	036	186
85.5	07	7	250.3	38	38	043	043	106
88.5	08	8	69.4	39	39	047	047	107
91.5	09	9	159.8	40	40	051	051	108
94.8	10	10	165.5	41	49	053	053	184
97.4	11	11	171.3	42	50	054	054	109
100.0	12	12	177.3	43	51	065	065	110
103.5	13	13	No Tone/Tone Off	44	0	071	071	111
107.2	14	14	183.5	45	41	072	072	112
110.9	15	15	189.9	46	42	073	073	113
114.8	16	16	196.6	47	43	074	074	114
118.8	17	17	199.5	48	44	114	114	115
123.0	18	18	206.5	49	45	115	115	116
127.3	19	19	229.1	50	46	116	116	117
131.8	20	20	254.1	51	47	122	122	185
136.5	21	21	71.0	N/A	48	125	125	118
141.3	22	22	198.0	N/A	52	131	131	119
146.2	23	23	202.7	N/A	53	132	132	120
151.4	24	24	Custom	N/A	54	134	134	121
156.7	25	24	Custom	N/A	55	143	143	122
162.2	26	26	Custom	N/A	56	145	145	187
167.9	27	27				152	152	123
173.8	28	28				155	155	124
179.9	29	29				156	156	125
186.2	30	30				162	162	126

SLX Tone Codes Cross-reference Charts

Std QC_ Freq (Hz)	RITRON QC Code	SLX QC Code	Digital Code	Ritron DQC Code	SLX DQC Code	Digital Code	Ritron DQC Code	SLX DQC Code
No Tone	44	0	343	343	145	606	606	167
165	165	127	346	346	146	662	662	174
172	172	128	351	351	147	612	612	168
174	174	129	356	356	197	624	624	169
205	205	130	364	364	148	627	627	170
212	212	188	365	365	149	631	631	171
223	223	131	371	371	150	632	632	172
225	225	189	411	411	151	645	645	N/A
226	226	132	412	412	152	654	654	173
243	243	133	413	413	153	664	664	175
244	244	134	423	423	154	703	703	176
245	245	135	431	431	155	712	712	177
246	246	190	432	432	156	723	723	178
251	251	136	445	445	157	731	731	179
252	252	191	446	446	198	732	732	180
255	255	192	452	452	199	734	734	181
261	261	137	454	454	200	743	743	182
263	263	138	455	455	201	754	754	183
265	265	139	462	462	202			
266	266	193	464	464	158			
271	271	140	465	465	159			
274	274	194	466	466	160			
306	306	141	503	503	161			
311	311	142	506	506	162			
315	315	143	516	516	163			
325	325	195	523	523	203			
331	331	144	N/A	526	204			
332	332	196	532	532	164			
			546	546	165			
			565	565	166			

SLX Antenna Cutting Chart

Antennas supplied with the SLX Series are pre-cut for operation in either VHF 150-165 MHz or UHF 450 - 470 MHz band.

AF-X100 VHF Uncut Antenna		AF-X400 UHF Uncut Antenna		AF-X450S UHF Stubby Uncut Antenna	
Freq (MHz)	Length (mm)	Freq (MHz)	Length (mm)	Freq (MHz)	Length (mm)
136	150	420	170	400	113
140	149	430	165	410	110
145	143	440	161	420	107
150	137	450	156	430	105
155	133	460	152	440	103
160	129	470	148	450	100
165	125	480	143	460	98
170	121			470	96
175	118			480	94

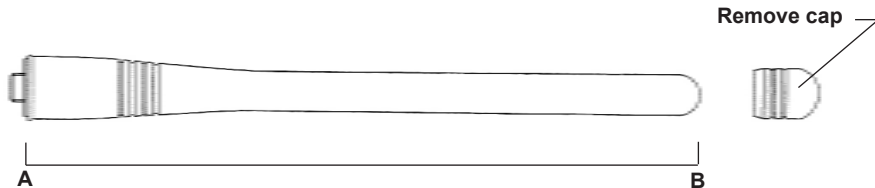

Measurement must be taken from point A to point B at the end of the antenna. Cap removed.

Note: Drawing is not to scale.

Compatible Ritron Radios

Wireless Intercomm/Base Station

Fixed location 2-way radio, desktop or wall-mount capable. Never needs recharging, it's AC powered.



OutPost XT Callbox

Talk at the push of a button to radio equipped personnel. Improves safety and workflow.

Shown with optional entry keypad

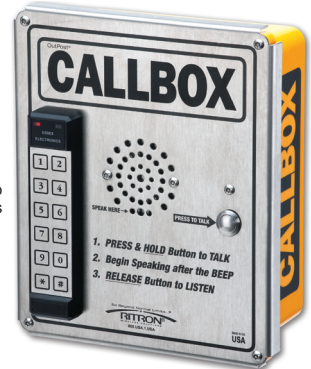

RPM 60 Series Mobile Radio

Tough and rugged mobile 2-way radios permit an efficient mobile command center for an array of commercial applications.



LoudMouth Wireless PA System

The ideal solution where a hard wire PA is simply impossible or too expensive to route between locations.



Have questions? Call **800-USA-1-USA** (800-872-1872) or visit our website at www.ritron.com

Go Beyond Normal Limits...SM



505 West Carmel Drive • Carmel, IN 46032 • USA

P. O. Box 1998 • Carmel, IN 46082-1998 • USA

Ph: 317-846-1201 • Fax: 317-846-4978 • Email: ritron@ritron.com • Website: www.ritron.com

© 2006-2008 Ritron, Inc. All rights reserved. Ritron, Patriot, Jobcom, OutPost, RadioNexus, GateGuard, Quiet Call and Quick Assist are registered trademarks of Ritron, Inc. Quick Talk and Liberty are trademarks of Ritron, Inc. Specifications subject to change without notice.