

RITRON®

Quick Assist®

**WIRELESS CALLBOX
TRANSMITTER**



Optional Message Placard Pt. No. 14280011
installed on RQT-PB.

Basic Owner's Manual

**MODELS: RQT- 150-PB (VHF)
RQT- 450-PB (UHF)**

Website: www.ritron.com



Pub. No. 14500019 Rev.H 10-02

Copyright© 2002, 1999 RITRON, INC. ALL RIGHTS RESERVED
RITRON, Quick Assist, and Quiet Call are registered trademarks of RITRON, INC.
Quick Talk is trademark of RITRON, INC.

P.O. Box 1998, Carmel, IN 46032-1998 • 505 W. Carmel Dr., Carmel, IN 46032 • USA
PH: 317-846-1201; 800-USA-1-USA (800-872-1872) • FAX: 317-846-4978
E-mail: quickassist@ritron.com



TABLE OF CONTENTS

DESCRIPTION	PAGE
WHAT THIS MANUAL COVERS	<i>ii</i>
WARNINGS AND CAUTIONS	<i>ii</i>
ACCESSORIES AND OPTIONS	<i>ii</i>
INTRODUCTION	1
General Information	1
Care and Maintenance	1
PROGRAMMING	2
Before Programming the Unit	2
Programming the Transmitter Frequency	2
Quiet Call Coded Squelch Codes	2
Digital Quiet Call Squelch Codes	2
Transmit Codes	3
Quiet Call Tone Codes	3
Programming the Initial Message	4
Programming Voice Phrase Repetitions	4
Programming the All Clear Message	4
Recording Low Battery Message	4
Limiting the Number of Transmissions	4
Setting Narrow/Wide-band Channels	5
Companded Audio Selector	5
Settings for Battery type	5
Connecting to an External Power Supply	6
CONTROLS & CONNECTORS	7
INSTALLATION	8
RITRON WIRELESS SOLUTIONS	9
F.C.C. LICENSING	11
WARRANTY	11

ACCESSORIES FOR QUICK ASSIST

These replacement and optional items are available from Ritron and its authorized dealers.

Item	Description
14280010	3-sided "NEED SALES HELP?" Placard
14280011	3-sided "NEED SERVICE?" Placard
14280009	1-sided "NEED SALES HELP?" Placard
RAM-1545	Magnet-Mount Antenna
25605600	Cover Gasket

WHAT THIS MANUAL COVERS

This manual covers the basic operation of the Quick Assist Wireless Shopper's Callbox Transmitter. For most applications, this is all the information you will need.

However, if you have specific questions or need assistance call Ritron at 317-846-1201, or visit the Ritron website at www.ritron.com.

— — — WARNING — — —

IMPORTANT SAFETY INFORMATION

NOTICE: The Quick Talk unit should not be used to report conditions relating to safety of life or property.

To reduce the risk of fire, electric shock or personal injury, follow these basic safety instructions when using this unit.

1. Read and follow all instructions.
2. Disconnect the unit before cleaning. Do not use liquid or aerosol cleaners.
3. Use only approved power sources for the unit.
4. During thunderstorms, avoid contact with this unit and any external antenna system or wiring.
5. The Quick Talk switch and external power terminals are connected internally to the antenna connector. If the Quick Talk switch or power supply terminals contact high voltage, a hazardous condition may exist in that contacting the antenna could prove injurious or even fatal.
6. In general, the switches you connect to the Quick Talk are to be independent dry contact switches, and not part of any other "live" electrical circuit
7. If you are unsure whether your installation will be safe, contact an experienced electrician or electronics technician.

QUICK ASSIST APPLICATION

The Quick Assist is a radio transmitter, specialized for retail or commercial use, and pre-programmed to transmit a custom-recorded "assistance needed" message when the Message push-button is pressed for customer assistance. Personnel know from these message transmissions in which specific areas a customer needs assistance.

The Quick Assist is also equipped with a Reset push-button for the use of personnel. When the Reset push-button is pressed (which stops the "assistance needed" message and resets the unit), the Quick Assist transmits a custom-programmed "assistance no longer needed" message, to further inform store personnel.

CAUTION !!

Remove the unit from the wall or other mounting surface before changing batteries.

The Cover Gasket (Pt. No. 25605600) must be in good condition and correctly installed to seal against environmental hazards for outdoor operation.

CAUTION: If the Cover Gasket is crimped, damaged or incorrectly installed, rain will leak into the unit, causing severe damage, and voiding the warranty. Replace any damaged Gasket.

- Place the Cover Assembly on a flat horizontal surface with the recessed side up. Carefully seat the Gasket in the recess of the Cover (refer to FIG-1 at right).
- Reconnect the In-line Connectors (refer to page 7). With the Gasket side of the Cover Assembly up, insert the case into the recess.
- Replace the four (4) Cover screws. Snug down, but do not overtighten the screws; excessive force can break the plastic enclosure material.

FIG-1: COVER GASKET

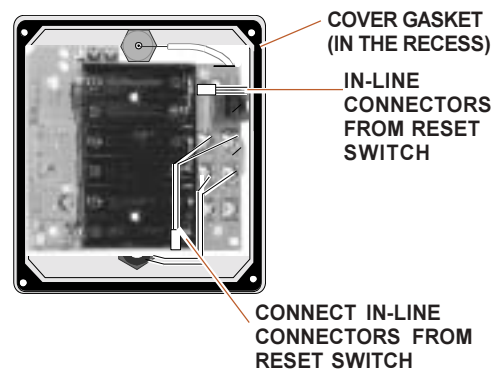

CARE & MAINTENANCE

Batteries: Use only fresh, new alkaline batteries when programming Quick Assist. Acceptable brands and types are: Duracell MX1500B, Eveready E91, Rayovac 815, or equivalent.

NOTE: Refer to page 6 of this manual for information on using rechargeable NiCad AA batteries, charged by an optional external 12 Volt DC power supply.

Estimated Battery Life: Starting with a fresh set of AA alkaline batteries, Quick Assist can transmit about 7,000 voice messages over a period of one year before the batteries will need replacement.

Automatic Low Battery Alert Message: If the battery voltage drops below approximately 6 Volts, the Quick Assist transmits the factory prerecorded message "Low Battery" every 60 minutes. When this occurs, replace the batteries promptly — within a day or so.

Temperature: The Quick Assist is designed to operate between -22 and +140 °F. Within this temperature range, good radio performance also depends on specifications of batteries powering the unit. Alkaline battery power decreases in extreme cold—e.g.: a power loss of 20% at 14 °F. Like all electronic equipment, Quick Assist should not be subjected to extreme heat. A shaded area is an ideal outdoor location.

Moisture: When Cover Gasket (above) and Antenna sealant (page 8) recommendations are followed, the Quick Assist is highly weather-resistant to outdoor environments. **Do not immerse the unit in water.**

Vibrations/ Shocks: Although it is of rugged design, the Quick Assist cannot be expected to survive extreme abuse.

Chemicals: Do not use harsh, corrosive or abrasive chemicals to clean the Quick Assist case; use only a cloth moistened with water. Do not attempt to clean the printed circuit board, which is located inside the housing.

BEFORE PROGRAMMING THE QUICK ASSIST:

1. Remove the Message Panel by pulling forward on the top of it.
2. Remove the (4) large screws at the corners of the gray enclosure.
3. Lift the cover from the unit. Use care to not damage or disturb any exposed internal components.
4. Plug a telephone unit that passes the following test into the telephone jack on the radio board.

IMPORTANT

The telephone must be capable of "Pulse" mode dialing. Most specialized and office telephones, speaker phones, those with lighted dials and that generate only Touch Tones CANNOT BE USED to program the Quick Talk. If the telephone has a mode selection switch, it must be set to "P" (Pulse), rather than "T" (Tone), to program the Quick Talk.

- The telephone must have a cord with a standard modular plug.
- Test the telephone for suitability by plugging it into the telephone jack of the Quick Talk, then dialing "O" (Operator). A repeating busy signal in the telephone earpiece indicates it is acceptable for programming the Quick Talk.

5. Disconnect the Antenna and the Rest Push-button in-line connectors. See FIG-2, page 4.
6. Remove batteries from the unit. Install a **fresh set** of six AA alkaline batteries, matching polarity marks on the batteries with the marks in the battery holder.
7. Reconnect the Antenna connector to the antenna, and the Reset in-line connector to the Reset Push-button.
IMPORTANT: THE ANTENNA AND RESET CONNECTORS MUST BE CONNECTED in order to program the unit !!
8. Program the Quick Assist as follows:

A. TO PROGRAM THE TRANSMITTER FREQUENCY:

1. Determine the frequency of your radio system.
2. Find your frequency in Table 1, page 2, then determine its corresponding two-digit code. If your frequency is not listed in Table 1, skip to Step 7. Otherwise, go on to Step 3:

For frequencies listed in Table 1:

3. Pick up the telephone receiver and listen for the acknowledge tone.
4. Dial "11", then enter the digits of your frequency code from Table 1.

EXAMPLES: If your Quick Assist is a **VHF RQT-150-PB** operating on the frequency 154.570 MHz, dial "1102".
If your Quick Assist is a **UHF RQT-450-PB** operating on the frequency of 467.925 MHz, dial "1108".

5. Quick Assist responds with a single beep to indicate the transmitter frequency programming is completed.
6. You may either continue programming additional features, or you may dial "999" and hang up to stop programming.

For frequencies not listed in Table 1:

7. Pick up the telephone receiver and listen for the acknowledge tone.
8. Dial "12", then the first six digits of your frequency.

EXAMPLES: If your Quick Assist is a **VHF RQT-150-PB** operating on a frequency of 153.220 MHz, dial "12153220".
If your Quick Assist is a **UHF RQT-450-PB** operating on a frequency of 464.3125 MHz, dial "12464312".

9. Quick Assist responds with a single beep to indicate it has programmed the transmitter frequency.
10. You may either continue programming additional features, or you may dial "999" and hang up the telephone to stop programming.

B. TO PROGRAM THE QUIET CALL SUB-AUDIBLE CODED SQUELCH INTERFERENCE ELIMINATOR:

1. Determine if your radio system uses QC- or DQC-coded tones. To program DQC tones, skip to Step 7.

For QC codes:

2. Find your QC tone frequency and its corresponding 2-digit code in Table 2, page 2.

NOTE: If your radio system does not use coded squelch, program No Tone Code "44".

3. Pick up the telephone receiver and listen for the acknowledge tone.
4. Dial "21", then enter the 2-digit code from Table 2.

EXAMPLE: If your QC frequency is 103.5 (Code 13), dial "2113".

5. Quick Assist responds with a single beep to indicate it has programmed the QC code.
6. You may either continue programming additional features, or you may dial "999" and hang up the telephone to stop programming.

For DQC codes:

7. Find your 3-digit DQC Code in Table 3, page 2. If your code does not appear in Table 3, call your radio service provider or Ritron.

8. Pick up the telephone receiver and listen for the acknowledge tone.

9. Dial "22", then enter the 3-digit DQC code from Table 3.

EXAMPLE: If your DQC code is 131, dial "22131".

10. Quick Assist responds with a single beep to indicate it has programmed the DQC code.
11. You may either continue programming additional features, or you may dial "999" and hang up the telephone to stop programming.

(Programming Instructions continued on page 4)

TABLE 1: TRANSMIT FREQUENCY CODES

(VHF Business Band)

(UHF Business Band)

QUICK ASSIST FREQ. CODE	Model RQT-150-PB		QUICK ASSIST FREQ. CODE	Model RQT-450-PB	
	MHz	Frequency Color		MHz	Frequency Color
01	154.600 Green Dot	01	467.7625 J
02	154.570 Blue Dot	02	467.8125 K
03	151.625 Red Dot	03	464.5500 Yellow Dot
04	151.955 Purple Dot	04	464.5000 Brown Dot
05	151.925		05	467.8500 Silver Star
06	154.540		06	467.8750 Gold Star
07	154.515		07	467.9000 Red Star
08	154.655		08	467.9250 Blue Star
09	151.685		09	469.2625	
10	151.715		10	462.5750 White Dot
11	151.775		11	462.6250 Black Dot
12	151.805		12	462.6750 Orange Dot
13	151.835		13	464.3250	
14	151.895		14	464.8250	
15	154.490		15	469.5000	
16	151.655		16	469.5500	
17	151.745		17	463.2625	
18	151.865		18	464.9125	
			19	464.6000	
			20	464.7000	

TABLE 2: QUIET CALL TONE CODES

QUICK ASSIST QC CODE	Freq. (Hz)	Other Radio Brands Tone Code	QUICK ASSIST QC CODE	Freq. (Hz)	Other Radio Brands Tone Code
01	67.0	XZ	27	167.9	6Z
02	71.9	XA	28	173.8	6A
03	74.4	WA	29	179.9	6B
04	77.0	XB	30	186.2	7Z
05	79.7	SP	31	192.8	7A
06	82.5	YZ	32	203.5	M1
07	85.4	YA	33	210.7	--
08	88.5	YB	34	218.1	--
09	91.5	ZZ	35	225.7	--
10	94.8	ZA	36	233.6	--
11	97.4	ZB	37	241.8	--
12	100.0	1Z	38	250.3	--
13	103.5	1A	39	69.4	--
14	107.2	1B	40	159.8	--
15	110.9	2Z	41	165.5	--
16	114.8	2A	42	171.3	--
17	118.8	2B	43	177.3	--
18	123.0	3Z	*44	No Tone	--
19	127.3	3A	45	183.5	--
20	131.8	3B	46	189.9	--
21	136.5	4Z	47	196.6	--
22	141.3	4A	48	199.5	--
23	146.2	4B	49	206.5	--
24	151.4	5Z	50	229.1	--
25	156.7	5A	51	254.1	--
26	162.2	5B			

TABLE 3: DIGITAL QUIET CALL CODES

Normal	Invert	Normal	Invert	Normal	Invert
023	047	174	074	445	043
025	244	205	263	464	026
026	464	223	134	465	331
031	627	226	411	466	662
032	051	243	351	503	162
043	445	244	025	506	073
047	023	245	072	516	432
051	032	251	165	532	343
054	413	261	732	546	132
065	271	263	205	565	103
071	306	265	156	606	631
072	245	271	065	612	346
073	506	306	071	624	632
074	174	311	664	627	031
114	712	315	423	631	606
115	152	331	465	632	624
116	754	343	532	654	743
125	365	346	612	662	466
131	364	351	243	664	311
132	546	364	131	703	565
134	223	365	125	712	114
143	412	371	734	723	431
152	115	411	226	731	155
155	731	412	143	732	261
156	265	413	054	734	371
162	503	423	315	743	654
165	251	431	723	754	116
172	036	432	516		

C. TO PROGRAM THE "ASSISTANCE NEEDED" MESSAGE:

1. Pick up the telephone receiver and listen for the acknowledge tone.
2. Dial "312". Quick Assist responds with three short tones to prompt you to begin speaking, then records the message. This message is to be no longer than 8 seconds. **Remember: speak loudly and clearly.**

EXAMPLE: "Customer needs assistance in Aisle 9."

3. When you have finished speaking, press and release the telephone flash-hook.
4. You may either continue programming additional features, or you may dial "999" and hang up the telephone to stop programming.

NOTE: To review your recorded message, dial "412".

D. TO PROGRAM TIME BETWEEN REPEATED MESSAGES: (DEFAULT SETTING IS 30 SECONDS)

1. Look up the code for the desired time between messages on Table 4, below.
2. Pick up the telephone receiver and listen for the acknowledge tone.
3. Dial "512", then the code digit from Table 4.

EXAMPLE: If you select 2 minutes as the time between messages, dial "5124".

4. Quick Assist responds with a single beep to indicate it has programmed the time between messages.
5. You may either continue programming additional features, or you may dial "999" and hang up the telephone to stop programming.

TABLE 4:

TIME BETWEEN MESSAGES	CODE NUMBER
No Message	0
On Changes Only	1
30 seconds	2 — DEFAULT
1 minute	3
2 minutes	4
5 minutes	5
10 minutes	6
30 minutes	7
1 hour	8
2 hours	9

E. TO PROGRAM THE "ASSISTANCE IS NO LONGER NEEDED" MESSAGE:

1. Pick up the telephone receiver and listen for the acknowledge tone.
2. Dial "311". Quick Assist responds with three short tones to prompt you to begin speaking, then records the message. This message is to be no longer than 8 seconds.

EXAMPLE: "Aisle 9 OK."

3. When you have finished speaking, press and release the telephone flash-hook.
4. You may either continue programming additional features, or you may dial "999" and hang up the telephone to stop programming.

NOTE: To review your recorded message, press "41"

F. TO PROGRAM THE "LOW BATTERY" MESSAGE:

1. Pick up the telephone receiver and listen for the acknowledge tone.
2. Dial "35". Quick Assist responds with three short tones to prompt you to begin speaking, then records the message. This message is to be no longer than 1.5 seconds.

EXAMPLE: "Low battery Aisle 9"

3. When you have finished speaking, press and release the telephone flash-hook.
4. You may either continue programming additional features, or you may dial "999" and hang up the telephone to stop programming.

NOTE: To review your recorded message, dial "45".

G. TO PROGRAM THE "ASSISTANCE NEEDED" MESSAGE REPEAT LIMIT: (DEFAULT SETTING IS 8 TIMES)

1. Look up the code for the desired number of message repeats on Table 5, below.
2. Pick up the telephone receiver and listen for the acknowledge tone.
3. Dial "612", then the code digit from Table 5.

EXAMPLE: If you select 3 times as the message repeat limit, dial "6123".

4. Quick Assist responds with a single beep to indicate it has programmed the message repeat limit.
5. Dial "999" and hang up the telephone to stop programming.

TABLE 5:

MESSAGE REPEAT LIMIT	CODE NUMBER
1 time	1
2 times	2
3 times	3
4 times	4
5 times	5
6 times	6
7 times	7
8 times	8 — DEFAULT
Repeat forever; no limit	9

!!! IMPORTANT !!!

If your Quick Assist unit fails to operate correctly, or is programmed incorrectly, put the unit into default Quick Assist mode using the following procedure:

1. Pick up the telephone receiver and listen for the acknowledge tone.
2. Dial the correct option (A or B below), to restore factory defaults; a short beep indicates successful completion.
 - A. For RQT-150-PB, dial "978".
 - B. For RQT-450-PB, dial "979".
3. Dial "814" to put the unit into "Quick Assist" mode; a short beep indicates successful completion.
4. Program Sections A through F, above. Section G is optional.
5. Programming of the Ritron Quick Assist is complete!

SETTING NARROW OR WIDE-BAND CHANNELS

Determine the frequency of your radios. This can be done by checking with your radio dealer, or if you are using "Color Dot" radios, match the color dot to the frequency table on Page 2. As a general rule, if your frequency has three or less numbers past the decimal point, your radio is set for wideband. Example 154.570 MHz, 462.625 MHz. If your frequency has more than three numbers past the decimal point, it is probably set for narrowband. Example: 467.7625 MHz, 467.8125.

Wide: (Refer to FIG-2)

To set your **Quick Assist** into wideband position, place the Transmitter Bandwidth Select Jumper so that both pins of the 2 pin connector are covered by the jumper.

Narrow: (Refer to FIG-2)

To set your **Quick Assist** into narrowband position, place the Transmitter Bandwidth Select Jumper so that only 1 pin of the 2 pin connector is covered by the jumper.

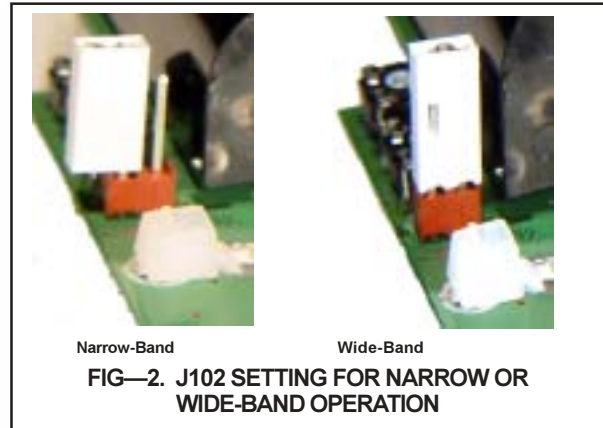

COMPRESSED/NOT-COMPRESSED AUDIO SELECTOR JUMPER

Some two-way radios have a feature referred to as "companding". It is a way of eliminating background "hiss" or noise, making the radio sound clearer. "Companding" is a combination of audio "COMPression" in the transmitter and audio "exPANDING" in the receiver. The **Quick Assist** can be set for audio compression by means of a program jumper. To determine if your existing 2-way radios are using the Companding feature, you can check the radio's User Manual, contact your radio dealer, or call Ritron for help.

Not-Compressed: (Refer to FIG-3)

To set the **Quick Assist** for standard audio or not-compressed, place the jumper so that the middle pin and the pin closest to the word "NON-COMP" are covered by the jumper.

Compressed: (Refer to FIG-3)

To set the **Quick Assist** for compressed audio, place the jumper so that the middle pin and the pin closest to the word "COMP" are covered by the jumper.

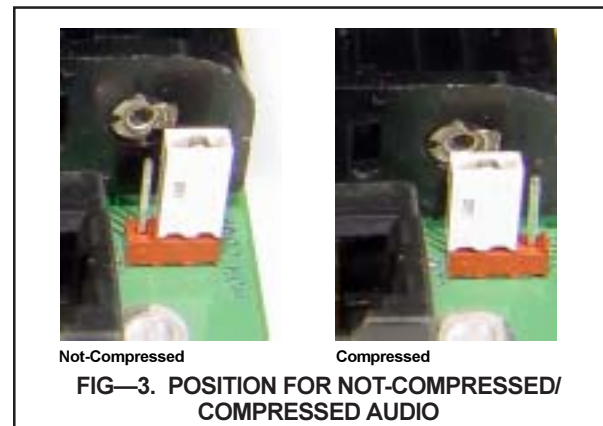

IMPORTANT

You may change the Transmitter Bandwidth and Compressed/Non-Compressed Audio jumper settings without re-recording your custom voice message.

If you are unable to determine if your portable radio does or does not use the companding feature, we suggest the following:

1. Leave the jumper in the factory default setting **NON-COMP**.
2. Activate the transmitter of the Quick Talk or Quick Assist (I or II) and listen to the message from your portable radio. If the received audio is acceptable, skip the rest of this section, if it's not acceptable continue to step #3.
3. Change the jumper setting to the **COMP** position and activate the Quick Talk or Quick Assist (I or II) transmitter again, and listen to the voice message.

Place the jumper in the setting that produces the best "received" audio message in the radio you will be using.

J103 JUMPER SETTINGS FOR BATTERY TYPE

NOTE: When programming, use either fresh Alkaline batteries (or an external power supply), to power the Quick Assist. When programming is finished, you may either insert Ni-Cd batteries or leave Alkaline batteries in place.

WARNING: DO NOT attempt to charge Alkaline batteries from an external +12VDC power supply.

When powering Quick Assist with **ALKALINE BATTERIES**, set J103 as follows to disconnect the charging current paths:

- To set the Quick Assist for use with alkaline batteries, move Jumper J103 to cover only one pin of the jumper base, as shown in FIG-4; this setting prevents the flow of charging current.
- Dial "943" to program the Quick Assist for use with alkaline batteries.

When powering Quick Assist with **NI-CD BATTERIES**, set J103 as follows to connect the charging current paths:

- Cover both pins with Jumper J103, as shown in FIG-4, to charge the Ni-Cd batteries from the External Power connection.
- Dial "944" to adjust the Quick Talk voltage; the unit then transmits a "Low Battery" phrase.

NOTE: Because Ni-Cd batteries self-discharge rapidly, constantly charge them with external +12VDC power.

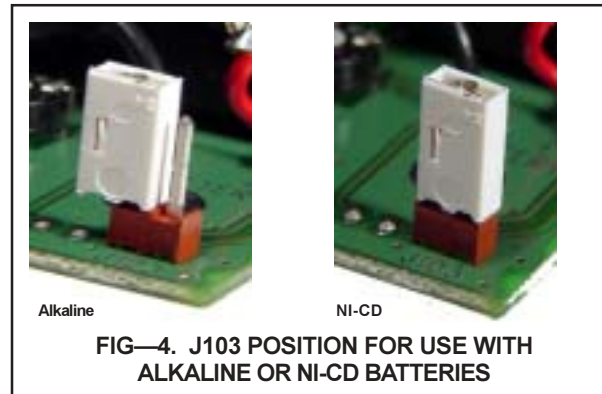

CONNECTING AN EXTERNAL 12 VDC POWER SUPPLY

TO CONNECT AN EXTERNAL 12 VDC POWER SUPPLY:

The standard Quick Assist is not set-up for use with an external power supply.

To modify the Quick Assist for use with an external power supply, use the following instructions.

- Carefully drill or punch a 0.484" hole in the bottom of the Quick Assist enclosure.
- Install Ritron #02500127 strain relief into the drilled hole.
- Use Ritron #RPS-203 Power Supply (11-15 VDC, 200 mA), or equivalent, to power the Quick Assist. The Quick Assist requires 11-15 VDC, 150 mA minimum.
- Connect the External Power Supply to Quick Assist positive and negative terminals, as shown in FIG-6.

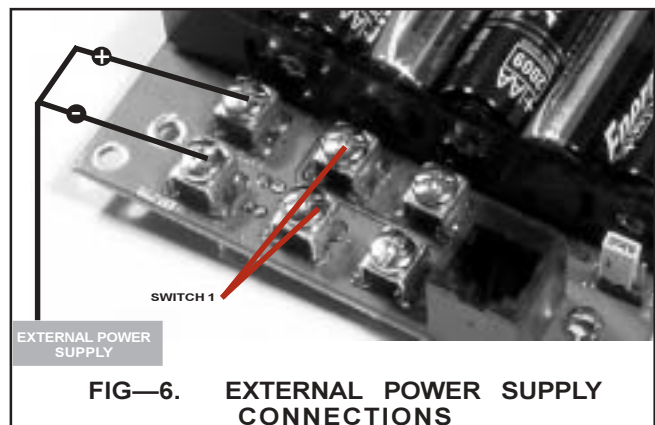

IDENTIFICATION OF CONTROLS AND CONNECTIONS

1 ANTENNA CONNECTOR

The antenna radiates radio signals. Before using **Quick Assist**, make sure the antenna is fastened securely to this connector. See page 8.

2 TELEPHONE JACK

The modular telephone jack provides temporary connection to a standard pulse or rotary mode telephone unit, which is used by the owner to program **Quick Assist** voice messages and other settings. Refer to FIG-7 below.

WARNING: DO NOT connect the Quick Assist to a line from the telephone company; doing so will damage the unit, and void the manufacturer's warranty.

3 BATTERY HOLDER

The battery holder accommodates the six (6) standard "AA" alkaline cells required to power the **Quick Assist**.

NOTE: ALWAYS INSTALL A FRESH SET of alkaline batteries before programming the unit.

4 SWITCH #1 TERMINALS

Switch #1 terminals connect to the unit's front panel (customer) push-button. When the button is pressed and released, the **Quick Assist** transmits a voice message (typically, a Customer Assistance message).

5 SWITCH #2 TERMINALS

Switch #2 terminals connect to the reset switch on the bottom of the unit. When this reset button is pressed and released, the **Quick Assist** transmits a voice message (typically, a Reset message).

6 EXTERNAL POWER TERMINALS

Refer to page 6 for information to connect an external 12 VDC power supply to these terminals.

7 FRONT PANEL (CUSTOMER SERVICE) PUSH-BUTTON

When this push-button is pressed and released, the **Quick Assist** transmits a voice message (typically, a Customer Assistance message).

8 TRANSMITTER BANDWIDTH SELECT JUMPER

DO NOT remove this jumper. As described on page 5, this jumper controls selection of wide or narrow bandwidth.

9 BATTERY TYPE SELECT JUMPER

DO NOT remove this jumper. As described on page 5 this jumper controls charging the optional Ni-Cd batteries.

10. COMPRESSED/NOT-COMPRESSED AUDIO SELECTOR

Do not remove this jumper. The **Quick Assist** can be used with two-way radios that use "companded audio." For radios with Companded Audio -place the jumper in the COMP position. For radios without Companded Audio - place the jumper in the NON-COMP position. To determine if your radio uses companded audio, call Ritron or your radio supplier.

IMPORTANT:

Do not remove any other fasteners or further disassemble the **Quick Assist** unit; doing so risks damage to the unit and voiding the manufacturer's warranty.

FIG-7: CONTROL & CONNECTION LOCATIONS

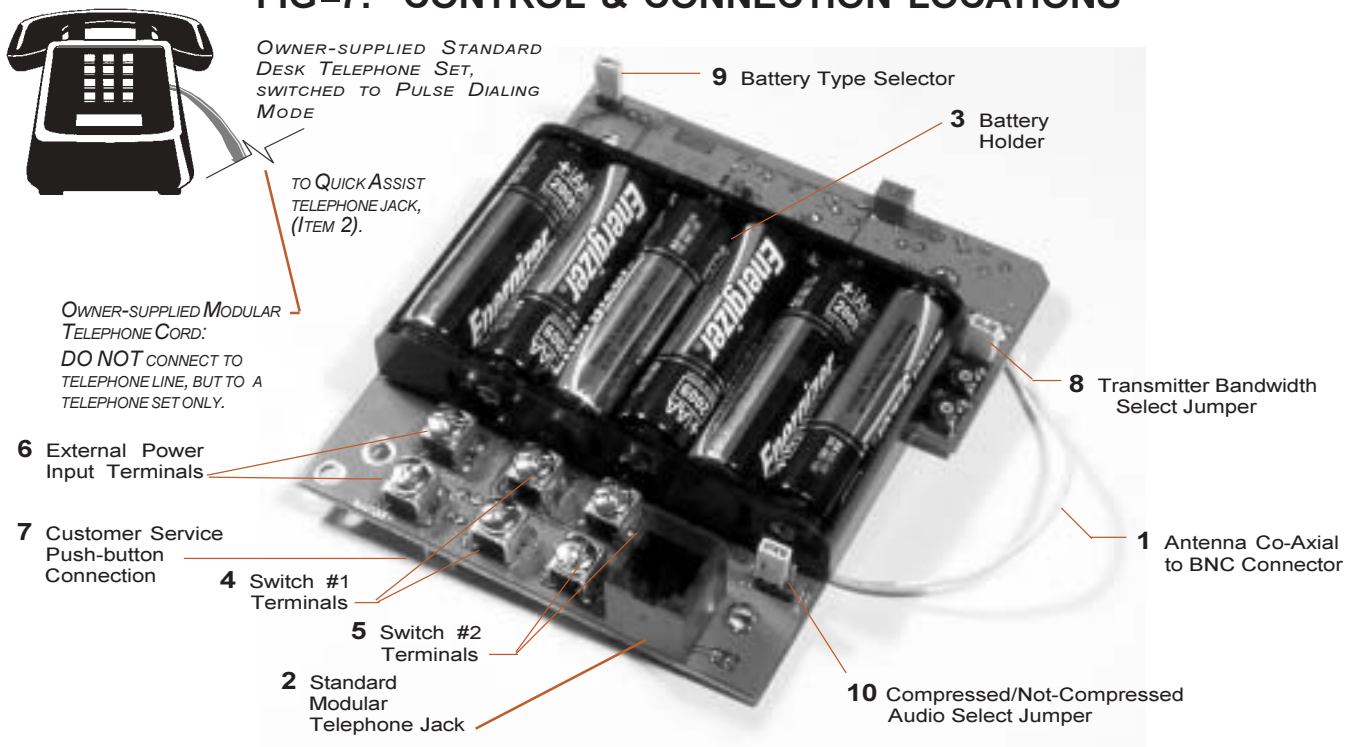

For assistance, call RITRON at 800-USA-1-USA (800-872-1872) or visit us at www.ritron.com

QUICK ASSIST INSTALLATION



FIG.-8: QUICK ASSIST INSTALLATION

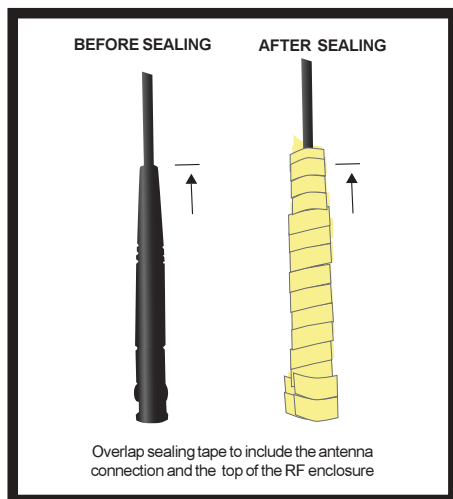

WHEN YOU ARE FINISHED PROGRAMMING:

1. **Hang up and disconnect** the telephone from the internal jack on the Quick Assist.
2. **Test the operation** of the Quick Assist before putting it into service by activating both switches: first press the Customer Service push-button on the front of the unit, then press the Reset push-button on the bottom of the unit. Listen to the messages received on your radio.
3. **Replace the cover** and (4) cover screws. Snug down, but **do not overtighten the screws**; excessive force can break the plastic enclosure material.

NOTE: See page 1 for installation of the Cover Gasket.

4. **Attach the antenna and seal the connection:**
 - a. Insert, rotate and lock the antenna to the Quick Assist antenna jack.
 - b. Orient the antenna in a vertical position.
 - c. Seal the antenna connection to hold the antenna in vertical position, to protect antenna fittings, and to maintain water-resistance of the Quick Assist in wet or outdoor environments.

NOTICE: If the unit is to be used outdoors, the antenna connection **must be sealed** with waterproof, self-fusing tape.

Use: Grainger Pt. # 2A459, McMaster-Carr Pt. #7643A34, or RadioShack Pt. # 278-1645

Wrap the connection with sealant tape and press it securely in place. (Refer to sealant instructions.)

5. **To install the Optional Message Placard**, align it with the center of its hole over the front push-button; also align the mushroom head fastener strips on the back of the panel with those on the front of the RQT cover. Press firmly to interlock the strips together, snapping the panel into position.
6. **Test for sufficient broadcast range** when choosing the location for the Quick Assist unit. For maximum range and coverage, install it as high from ground level as possible. Be aware that metal or wires near the antenna can block or absorb radio transmissions. If the installation is outdoors, choose a well-shaded location.

NOTE: An optional high gain antenna is available from Ritron; call 800-USA-1-USA for information.

7. **Position the unit** as shown in FIG.-8, and secure it in place with screws through the enclosure flanges. **Do not overtighten** these screws, as you might break the plastic flanges.

IMPORTANT: Contact a qualified technician or electrician if you are not certain your installation will work properly and safely.

Complete Wireless Communication Solutions From The Leader in Workplace Two-Way Radio Systems

Ritron - We Build Wireless Solutions

For nearly 3 decades Ritron has been designing, manufacturing, and supplying reliable, professional wireless communication products for users worldwide. Ritron wireless products will improve the operation, safety, and profitability of any organization by providing instant voice communication between key employees throughout the workplace.



Portable Radios

Communicate with multiple workgroups instantly with a push-of-the-button. Rugged and lightweight with built-in weather scan (VHF models only) automatically finds NOAA broadcasts. Other features include Interference Eliminator, Loud and Clear Audio, Removable Quick Swap Battery, and Drop-in Charging Capability.

Accessories

Ritron offers a wide variety of headsets, earsets, remote speaker microphones, multi-unit chargers, and carry holsters to meet all your wireless communication needs.



Desktop 2-way Base Station

110 VAC or 12 VDC desktop or wall mountable radio that is compatible with any VHF/UHF radio system. Includes built-in Weather Scan (VHF models only), loud audio output for noisy locations, built-in microphone with automatic gain control, and rugged metal housing. Optional Public Address (PA) modification available.

Ideal for in-plant • schools • retail stores • jobsite vehicles • community repeater systems, loading docks • construction trailers or anywhere that fixed two-way communication is needed.

Advantages of Ritron Wireless Products:

- Unique products and features not available from any other source
- Adds speed, flexibility, and responsiveness to any organization
- Fully compatible with virtually any existing two-way radio system
- Designed to work together as a complete system
- No monthly service fees or airtime charges
- Made in the U.S.A.

OutPost™

Wireless Radio Callboxes

Battery-operated (6 alkaline "D" cells) callboxes, available in basic or rugged models, provide instant wireless communication over existing two-way radio systems without costly trenching, extensive wiring, or dedicated phone lines.

Ideal for Hotels/Motels • Golf Courses • Schools, Public Parks • Playgrounds • Roadsides • Marinas • Parking Lots or Garages • Receiving or Delivery Docks • Campuses • Shopping Malls • Beachs and Pools • Campgrounds and Hiking Trails • Unattended Gates.



It's like being in 2 places at once!

Quick Talk™

Wireless Voice Alarm Reporter

No need to run wires, phone lines, or pay a person for 24/7 monitoring. The low-cost, battery-operated (6 alkaline "AA" cells) Quick Talk Reporter permits wireless monitoring of virtually any sensor or switch from a two-way radio. When the switch opens or closes, a user recordable "custom" voice message is automatically transmitted to all radios on the same channel frequency.

Ideal for remote monitoring of • power failures • liquid levels • intrusion or tampering • temperature sensing • unattended doors to name only a few of the 1000s of applications.



F.C.C. LICENSING AND REGULATIONS

The Rules and Regulations of the United States Federal Communications Commission (FCC) require you or your radio service provider to have a license for your radio system before activating the Quick Talk radio transmitter. If you already are operating a licensed radio system, you probably can add a Quick Talk without any changes to that license.

The station licensee is responsible for ensuring that transmitter power, frequency and modulation are within the limits specified by the station license, and also for proper operation and maintenance of the radio equipment. These responsibilities include checking the transmitter frequency and modulation periodically, using appropriate methods.

Ritron or your Ritron Dealer can assist you with all these requirements. You may also contact the FCC directly by any of the following methods:

To obtain copies of FCC forms and instructions use the FCC Fax-On-Demand system at **202-418-0177**. Request Document 000600.

For more information, go to the FCC Internet Website at: <http://www.fcc.gov>

SAFETY STANDARDS — The FCC has adopted a safety standard

for human exposure to radio frequency electromagnetic energy emitted by FCC regulated equipment. The Quick Talk conforms to the standards effective at the time of its equipment authorization by the FCC. In general these standards recommend that you:

- DO NOT allow the antenna to come very close to, or to touch exposed parts of the body, especially the face or eyes, while transmitting.
- DO NOT transmit near electrical blasting caps or in an explosive atmosphere.
- DO NOT allow children to play with radio transmitters.
- BE AWARE of the conditions which cause the unit to transmit.

SERVICE - Federal law prohibits you from making any internal adjustments to the transmitter, and from changing transmit frequencies unless you are specifically designated by the licensee.

DO NOT ADJUST OR TAMPER with components or the printed circuit board in any manner not directed in this manual. Unauthorized adjustments may render the unit inoperable; repair will be at owner's expense.

If your radio equipment fails to operate properly, or if you wish to have the Ritron Quick Talk serviced, contact your authorized dealer, or call Ritron at 317-846-1201 and ask for the Repair Department.

RITRON, INC. LIMITED WARRANTY

WHAT THIS WARRANTY COVERS: RITRON, INC. ("RITRON") provides the following warranty against defects in materials and/or workmanship in **RITRON RQ-150-PB AND RQT-450-PB QUICK ASSIST** Wireless Shopper's Callbox units under normal use and service during the applicable warranty period, as stated below. "Accessories" means antennas, chargers, wire, cable and items contained in the programming and programming/ service kits.

WHAT IS COVERED FOR HOW LONG WHAT RITRON WILL DO

Quick Assist	1 year *	During the first year after date of Telemetry Unit purchase, RITRON will repair or replace the defective product, at RITRON's option, parts and labor included at no charge.
Accessories	90 days *	*After date of purchase

WHAT THIS WARRANTY DOES NOT COVER:

- Any technical information provided with the covered product or any other products;
- Installation, maintenance or service of the product, unless this is covered by a separate written agreement with RITRON;
- Any products not furnished by RITRON which are attached or used with the covered product, or defects or damage from the use of the covered product with equipment that is not covered;
- Defects or damage, including broken antennas, resulting from:
 - misuse, abuse, improper maintenance, alteration, modification, neglect, accident or act of God, or,
 - the use of covered products other than in normal and customary manner, or,
 - improper testing or installation;
- Defects or damages from unauthorized disassembly, repair or modification, or where unauthorized disassembly, repair or modification prevents inspection and testing necessary to validate warranty claims;
- Defects or damages in which the serial number has been removed, altered or defaced.

IMPORTANT: This warranty sets forth the full extent of RITRON's express responsibilities regarding the covered products, and is given in lieu of all other express warranties. What RITRON has

agreed to do above is your sole and exclusive remedy. No person is authorized to make any other warranty to you on behalf of RITRON. Warranties implied by state law, such as implied warran-

ties of merchantability and fitness for a particular purpose, are limited to the duration of this limited warranty as it applies to the covered product. Incidental and consequential damages are not recoverable under this warranty (this includes loss of use or time, inconvenience, business interruption, commercial loss, lost profits or savings). Some states do not allow the exclusion or limitation of incidental or consequential damages, or limitation on how long an implied warranty lasts, so the above limitations or exclusions may not apply to you. Because each covered product system is unique, RITRON disclaims liability for range, coverage, or operation of the system as a whole under this warranty.

WHO IS COVERED BY THIS WARRANTY: This warranty is given only to the purchaser or lessee of covered products when acquired for use, not resale. This warranty is not assignable or transferable.

HOW TO GET WARRANTY SERVICE: To receive warranty service, you must deliver or send the defective product, delivery costs and insurance prepaid, within the applicable warranty period, to RITRON, INC., 505 West Carmel Drive, Carmel, Indiana 46032, Attention: Warranty Department. Please point out the nature of the defect in as much detail as you can. You must retain your sales or lease receipt (or other written evidence of the date of purchase) and deliver it along with the product. If RITRON chooses to repair or replace a defective product, RITRON may replace the product or any part or component with reconditioned product, parts or components. Replacements are covered for the balance of the original applicable warranty period. All replaced covered products, parts or components become RITRON's property.

RIGHTS TO SOFTWARE RETAINED: Title and all rights or licenses to patents, copyrights, trademarks and trade secrets in any RITRON software contained in covered products are and shall remain in RITRON. RITRON nevertheless grants you a limited non-exclusive, transferable right to use the RITRON software only in conjunction with covered products. No other license or right to the RITRON software is granted or permitted.

YOUR RIGHTS UNDER STATE LAW: This warranty gives you specific legal rights, and you may also have other rights which vary from state to state.

WHERE THIS WARRANTY IS VALID: This warranty is valid only within the United States, the District of Columbia and Puerto Rico.